



Road Book



XXII Rali da Calheta

3 e 4 de julho de 2026



NORMAS DE PREPARAÇÃO DO ROAD BOOK

Este Road Book foi preparado no mês de fevereiro de 2026 e corrigido em maio do mesmo ano. Alterações importantes serão indicadas nos boletins de Informação. A Comissão Organizadora não se responsabiliza por alterações inesperadas na sinalização de estradas e prestou especial atenção na preparação do Road Book, para que este seja de fácil uso e interpretação. Por esta razão, informação não considerada útil ou relevante foi omitida. Apenas os cruzamentos considerados úteis foram reproduzidos. Seguindo este critério, quando conduzir na estrada, deverá continuar na mesma via, até que o Road Book indique uma mudança de estrada ou direção.

O Local exacto do controlo será indicado por tinta branca na estrada, com as seguintes marcações: CH , P , STOP , META

Este Road Book foi cuidadosamente elaborado por parte do organizador. Agradecemos sugestões que nos permitam melhorar.



XXII Rali da Calheta

3 e 4 de julho de 2026



Comprovação e calibração do Terratrip

As distâncias sobre estrada foram medidas com recurso a um odómetro TERRATRIP 303 PLUS, servindo como referência para a sua calibração a VR1, entre os marcos quilométricos 18 e 19 no sentido Funchal - Santa Cruz. A distância entre os marcos acima indicados corresponde a 1 Km.

Distâncias medidas:

Na Estrada
do Km 18.0 ao Km 19.0 — 1.0

No Terratrip
1.0



XXII Rali da Calheta

3 e 4 de julho de 2026



CENTRO OPERACIONAL

Rali da Calheta

Junta de Freguesia dos Prazeres

E-mail: ralidacalheta@csmadeira.com

• • • • •

Na Junta de Freguesia dos Prazeres funcionará o Serviço de Informações para os Órgãos de Comunicação Social, vossas Famílias e Público em geral.

• • • • •

Se infelizmente tiver de abandonar o Rali, queira informar-nos através do telefone nº 291 148 889. A Organização e sobretudo a sua Família gostarão de saber notícias a seu respeito.



XXII Rali da Calheta

3 e 4 de julho de 2026



PROCEDIMENTO DE SEGURANÇA EM CASO DE ACIDENTE

- 1) Quando é mostrado a identificação "SOS" de cor vermelha, é **OBRIGATÓRIO** parar e prestar assistência à tripulação que necessita de ajuda. Você é responsável por ajudar os acidentados e assegurar-se de que os serviços de segurança foram mobilizados/acionados o mais rápido possível.
- 2) A primeira tripulação que chegue ao lugar do acidente deve parar e informar o seguinte veículo de todos os detalhes.
- 3) O seguinte veículo deve levar toda a informação recebida (detalhadamente) para o posto de telecomunicações seguinte, que poderá ser o controlo de chegada (Stop):
 - número de competição da viatura envolvida.
 - se há e quantos membros da tripulação e/ou pessoas do público estão feridas.
 - se há algum membro da equipa ou pessoa do público dentro ou fora do veículo.
 - localização do acidente, i.e. dizer qual o cruzamento ou Km mais perto, segundo o Road Book.
 - outra informação considerada vital, i.e., por exemplo fogo, água.
- 4) Os restantes veículos deverão parar se for mostrada a palavra "SOS" vermelha.
- 5) Todos os concorrentes que fiquem parados na estrada deverão colocar o triângulo vermelho a pelo menos 50 metros do local onde a viatura está imobilizada, mesmo se a mesma estiver fora de estrada.
- 6) O número de telefone em caso de emergência é: **291 148 889**.
- 7) Caso desista da prova deverá informar os organizadores através do número de telefone: **291 148 889**.
- 8) Todos os concorrentes que se retirem (desistam) da prova são obrigados a entregar a sua caderneta no controlo mais perto, o mais rapidamente possível.

Média horária do sector	Distância do sector	Número / nome da via	Tempo para percorrer o sector
CH 2A - SANTA	DISTÂNCIA	ETAPA	1
CH 3A - C. F. PRAZERES/M. ABASTECEDOR (NEAG.)	21.61 Km	SEÇÃO	2
Prova Especial	MÉDIA	TEMPO	35 MIN
<i>Golfe Calheta 1</i>	10.93 Km		

Distância		Direção	Informação	Dist. to go Dist. Regr.
Total	Parcial			
0.00	0.00	 1 10.93	ER 101 T-1 3 N 32°50'24.81" W 17°11'39.77"	21.61
1.79	1.79	 2 9.14	ER 101 FUNCHAL PONTA DO PARÇO T-2 N 32°50'24.84" W 17°12'31.85"	19.82
6.60	4.81	 3 4.33	ER 101 T-3 N 32°49'43.29" W 17°13'29.84"	15.01
8.81	2.21	 4 2.12	ER 101 RIBEIRA DA VACA T-4 N 32°49'18.39" W 17°13'55.38"	12.80
10.93	2.12	 5 0.00	ER 101 3 N 32°49'3.09" W 17°14'32.54"	10.68

Distância total desde o início do sector

Distância parcial desde o desenho precedente

Direção a seguir

















3
Número de PEC

Distância até ao controlo horário



















Distância para o final da PEC

Rali da Calheta 2026

SIMBOLOS

<p>Special Stage/Prova Especial 1A <i>Vila da Calheta 1</i> 2.97 Km/h</p> <p>IDENTIFICAÇÃO PROVA ESPECIAL</p>	 <p>PARQUE DE ASSISTÊNCIA</p>
<p> N 32°43'05" WO 16°47'59"</p> <p>ZONA DE HELICOPTERO</p>	 <p>FIM DE PARQUE DE ASSISTÊNCIA</p>
<p>N 32°43'13.36" W 17°10'35.61"</p> <p>COORDENADAS GEOGRÁFICAS</p>	 <p>ZONA DE REABASTECIMENTO</p>
 <p>CONTROLO HORÁRIO</p>	 <p>FIM DE ZONA DE REABASTECIMENTO</p>
 <p>PARTIDA PROVA ESPECIAL</p>	 <p>ZONA DE AQUECIMENTO DE PNEUS</p>
 <p>FIM PROVA ESPECIAL</p>	 <p>FIM DE ZONA DE AQUECIMENTO DE PNEUS</p>
 <p>PARAGEM FIM PROVA ESPECIAL</p>	 <p>AMBULÂNCIA</p>
 <p>POSTO RÁDIO / COMUNICAÇÃO</p>	 <p>BOMBEIROS</p>
 <p>TELEFONE</p>	 <p>PRONTO-SOCORRO</p>

SIMBOLOS

 <p>ATENÇÃO / PERIGO</p>	 <p>SEGUIR A Direção</p>
 <p>MÉDICOS</p>	 <p>VIA RÁPIDA</p>
 <p>TÚNEL</p>	 <p>ESTRADA REGIONAL</p>
 <p>CASA(S)</p>	 <p>ESTRADA MUNICIPAL</p>
 <p>PORTÃO</p>	 <p>ESTRADA FLORESTAL</p>
 <p>PONTE / MURO</p>	 <p>PEC</p>
 <p>ENTRADA DE CIDADE / VILA</p>	 <p>LIGAÇÃO CH - ZAP</p>
 <p>Direção A SEGUIR</p>	 <p>ZONA AQUECIMENTO DE PNEUS</p>
 <p>Direção A NÃO SEGUIR</p>	 <p>LIGAÇÃO ZAP - PARTIDA</p>



XXII Rali da Calheta

3 e 4 de julho de 2026



MAPA DE CONTROLOS DO RALI DA CALHETA 2026

SEXTA-FEIRA, 3 DE JULHO

1ª Etapa - 1ª Secção

Entrada em Pré Parque de Partida das viaturas admitidas - Campo de Futebol dos Prazeres Das 19:30 às 20:25 Horas

CH	Localização	Dist. PEC	Dist. Ligação	Dist. Total	Tempo	Hora 1º carro	Média Km/h
0	Partida - 1ª ETAPA - Parque Fechado - Saída - Campo de Futebol dos Prazeres					20:35	
0A	Vila da Calheta		12,08	12,08	00:22	20:57	32,95
SE 1A	Super Especial 1A - Vila da Calheta "Coral"	2,97			00:03	21:00	
1B	Vila da Calheta		11,14	14,11	00:22	21:22	38,48
SE 1B	Super Especial 1B - Vila da Calheta "Coral"	2,97			00:03	21:25	
1C	Service / Parque Assistências IN / Entrada		8,70	11,67	00:18	21:43	38,90
- Parque Assistências - A - Mercado Abastecedor da Calheta e Campo Futebol / Pavilhão dos Prazeres							
1D	Service / Parque Assistências OUT / SAÍDA				00:45	22:28	
1E	Parque Fechado - Entrada - Auto Silo Porto de Recreio da Calheta		12,22	12,22	00:20	22:48	36,66
Total 1ª Secção		5,94	44,14	50,08	02:13		

1ª Secção

SABADO, 4 DE JULHO

1ª Etapa - 2ª Secção

CH	Localização	Dist. PEC	Dist. Ligação	Dist. Total	Tempo	Hora 1º carro	Média Km/h
1F	Parque Fechado - Saída - Auto Silo Porto Recreio da Calheta					09:00	
1G	Parque Assistências - B - Entrada		8,85	8,85	00:15	09:15	35,40
- Parque Assistências - B - Mercado Abastecedor da Calheta e Campo Futebol / Pavilhão dos Prazeres							
1H	Parque Assistências - B - Saída				00:15	09:30	
REAB 1	Reabastecimento para todos os concorrentes Distância até ao próximo reabastecimento	37,18	60,56	97,74			
1I	Prazeres		9,96	9,96	00:22	09:52	27,16
2	SS / PEC 2 - Prazeres 1	7,66			00:03	09:55	
2A	Santa		9,63	17,29	00:27	10:22	38,42
3	SS / PEC3 - Golfe Calheta 1	10,93			00:03	10:25	
3A	Reagrupamento Entrada - Campo de Futebol dos Prazeres		10,68	21,61	00:35	11:00	37,05
Total 2ª Secção		18,59	30,27	48,86	02:00		

2ª Secção

1ª Etapa - 3ª Secção

3B	Reagrupamento Saída - Campo de Futebol dos Prazeres				00:18	11:18	32,93
3C	Prazeres		9,88	9,88	00:19	11:37	31,20
4	SS / PE 4 - Prazeres 2	7,66			00:03	11:40	
4A	Santa		9,63	17,29	00:27	12:07	38,42
5	SS / PEC 5 - Golfe Calheta 2	10,93			00:03	12:10	
5A	Reagrupamento Entrada - Campo de Futebol dos Prazeres		10,68	21,61	00:35	12:45	37,05
Total 3ª Secção		18,59	30,19	48,78	01:45		

3ª Secção



XXII Rali da Calheta

3 e 4 de julho de 2026



MAPA DE CONTROLOS DO RALI DA CALHETA 2026

SABADO, 4 DE JULHO

1ª Etapa - 4ª Secção

CH	Localização	Dist. PEC	Dist. Ligação	Dist. Total	Tempo	Hora 1º carro	Média Km/h
5B	Reagrupamento Saída - Campo de Futebol dos Prazeres Parque Assistências - C - Entrada		0,10	0,10	01:15	14:00	0,08
- Parque Assistências - C - Mercado Abastecedor da Calheta e Campo Futebol / Pavilhão dos Prazeres							
5C	Parque Assistências - C - Saída				00:30	14:30	
REAB 2 Reabastecimento para todos os concorrentes							
Distância até ao Final do Rali		44,02	62,43	106,45			
5D	Ponta do Pargo		10,06	10,06	00:22	14:52	27,44
6	SS / PEC 6 - Ponta do Pargo 1	11,83			00:03	14:55	
6A	Fonte do Bispo		13,84	25,67	00:37	15:32	41,63
7	SS / PEC 7 - Fonte do Bispo - Raposeira 1	10,18			00:03	15:35	
7A	Reagrupamento Entrada - Campo de Futebol dos Prazeres		7,06	17,24	00:25	16:00	41,38
Total 4ª Secção		22,01	31,06	53,07	03:15		

4ª Secção

1ª Etapa - 5ª Secção

7B	Reagrupamento Saída - Campo de Futebol dos Prazeres				00:15	16:15	39,92
7C	Ponta do Pargo		9,98	9,98	00:17	16:32	35,22
8	SS / PEC 8 - Ponta do Pargo 2	11,83			00:03	16:35	
8A	Fonte do Bispo		13,84	25,67	00:37	17:12	41,63
9	SS / PEC 9 - Fonte do Bispo - Raposeira 2	10,18			00:03	17:15	
9A	Parque Assistências - D - Entrada		7,16	17,34	00:25	17:40	41,62
- Service / Parque Assistências - D - Mercado Abastecedor da Calheta e Campo Futebol / Pavilhão dos Prazeres							
9B	Parque Assistências - D - Saída				00:10	17:50	
9C	Reagrupamento Entrada - Auto Silo Porto Recreio da Calheta		12,22	12,22	00:20	18:10	36,66
Total 5ª Secção		22,01	43,20	65,21	02:10		

5ª Secção

1ª Etapa - 6ª Secção

CH	Localização	Dist. Ligação	Dist. Total	Tempo	Hora 1º carro	Média Km/h	
9D	Reagrupamento Saída - Auto Silo Porto Recreio da Calheta			01:03	19:13		
Pódio - Marina da Calheta		0,05	0,05	00:02	19:15		
9E	Parque Fechado - Entrada - Auto Silo Porto Recreio da Calheta		0,44	0,44	00:05	19:20	5,28
Total 6ª Secção		0,49	0,49	01:10			

6ª Secção

TOTAL DO RALI

	PEC	Dist. Lig.	Dist. Total	Tempo	% PEC's
Total 1ª Secção	5,94	44,14	50,08	02:13	11,9%
Total 2ª Secção	18,59	30,27	48,86	02:00	38,0%
Total 3ª Secção	18,59	30,19	48,78	01:45	38,1%
Total 4ª Secção	22,01	31,06	53,07	03:15	41,5%
Total 5ª Secção	22,01	43,20	65,21	02:10	33,8%
Total 6ª Secção	0,00	0,49	0,49	01:10	0,0%
TOTAL - 9 PEC's	87,14	179,35	266,49	12:33	32,7%



XXII Rali da Calheta

3 e 4 de julho de 2026



NOTIFICAÇÃO DE ABANDONO DO RALI

Este formulário deve ser preenchido pelo Concorrente e entregue a um Comissário do Rali o mais rápido possível.

Nome do Condutor _____

Carro nº _____ Data _____ Hora _____

Motivo do Abandono _____

Algum elemento da equipa está ferido? _____

Onde podem ser localizados? _____

_____ Tel.: _____

Assinatura do Condutor _____

RECIBO

(Deve ser assinado pelo Comissário que receber a Notificação de Abandono)

Nome do Condutor _____

Carro nº _____ Data _____ Hora _____

Acuso a recepção da Notificação de Abandono do Rali anteriormente mencionado

Assinado _____

Nome do Comissário _____

Cargo do Comissário _____



XXII Rali da Calheta

3 e 4 de julho de 2026



RELATÓRIO DE ACIDENTE

Nota: É obrigatório o preenchimento deste formulário caso ocorra um acidente que provoque danos pessoais a concorrentes, elementos do público, ou danos materiais a bens pertencentes a não concorrentes.

Nome do Condutor _____ Carro nº _____

Nº de matrícula do carro _____ Data _____ Hora _____

Local da Ocorrência _____

Informações sobre terceiros envolvidos

Nome _____

Morada _____

Descrição do Acidente _____

Natureza dos danos físicos _____

Natureza dos danos materiais _____

Responsável pela elaboração do Inquérito

Nome _____

Local _____ Data _____ Hora _____

Recebido por _____ Assinatura _____



XXII Rali da Calheta

3 e 4 de julho de 2026



FICHA DE CONSULTA

Nota: Esta ficha de consulta deve ser entregue em mão ao “Relações com os Concorrentes”, Director da Prova ou seu Representante, no Secretariado do Rali.

Etapa N° _____	Concorrente N° _____
A consulta está relacionada com: _____ _____	
Prova Especial N° _____	ou Controlo Horário N° _____

Detalhes da consulta

Nome da pessoa que faz a consulta _____	
Função: _____	Assinatura: _____
Data: _____	Hora: _____

ACÇÃO

Nome do Oficial de Prova: _____

Função: _____ Assinatura: _____

Data: _____ Hora: _____



Mapas

SECRETARIADO • VERIFICAÇÕES ADMINISTRATIVAS E TÉCNICAS • PARQUE DE ASSISTÊNCIAS • PARQUE DE ASSISTÊNCIAS, S/ LOCALIZAÇÃO DAS EQUIPAS

1 Secretariado
Verificações Administrativas
Direção de Prova
Colégio CD

2 Estacionamento Direção de Prova
3 Reagrupamento
4 Acesso ao Parque de Assistências

5 Verificações Técnicas
6 Parque de Assistências
7 Saída Parque de Assistências

8 Reabastecimento
Zona de Pneu
WC e Ecoponto
Ilha Ecológica





ETAPA 1 - SECÇÃO 1

PROVAS ESPECIAIS DE CLASSIFICAÇÃO

Nº	NOME	KM	HORA	ENCERRAMENTO
1A	VILA DA CALHETA "CORAL"	2.97	21.00	20.00 - 23.30
1B	VILA DA CALHETA "CORAL"	2.97	21.25	

ALBUQUERQUE

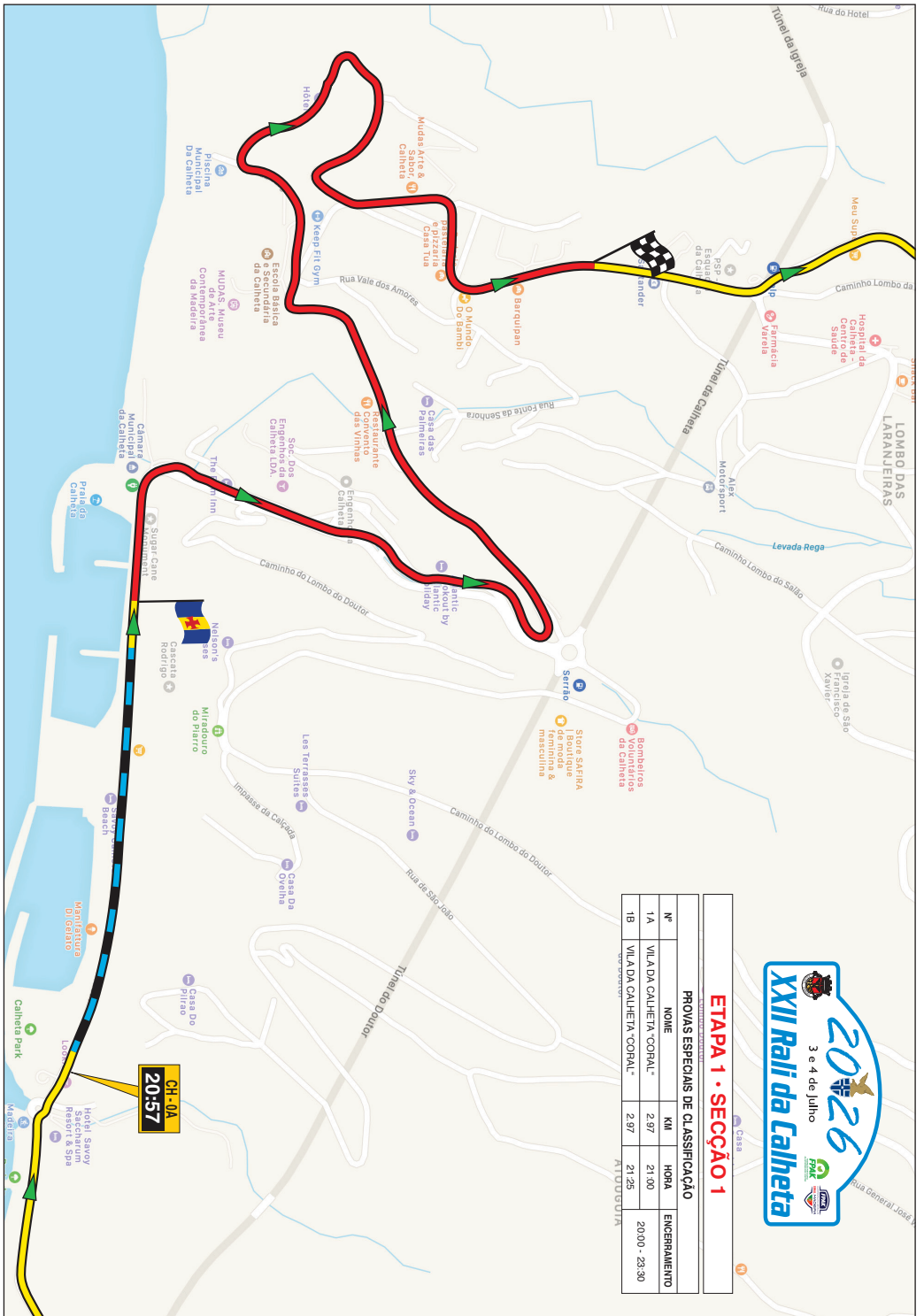



PF	PA
PA	2
2	3
3	RG
RG	4
4	5
5	RG

ETAPA 1 - SECÇÃO 2 e 3

PROVAS ESPECIAIS DE CLASSIFICAÇÃO				
Nº	NOME	KM	HORA	ENCERRAMENTO
2	PRAZERES 1	7.66	09:55	08:55 - 12:55
3	GOLFE CALHETA 1	10.93	10:25	09:25 - 13:25
4	PRAZERES 2	7.66	11:40	08:55 - 12:55
5	GOLFE CALHETA 2	10.93	12:10	09:25 - 13:25

Perque
Fechado
09:00



MAPA ALTERNATIVO

ETAPA 1 - SECÇÃO 2 e 3

PROVAS ESPECIAIS DE CLASSIFICAÇÃO						
Nº	NOME	KM	HORA	ENCERRAMENTO		
2	PAZIEIRES 1	7,66	09:55	08:55 - 12:55		
3	GOLFE CALHETA 1	10,93	10:25	09:25 - 12:25		
4	PAZIEIRES 2	7,66	11:40	08:55 - 12:55		
5	GOLFE CALHETA 2	10,93	12:10	09:25 - 12:25		

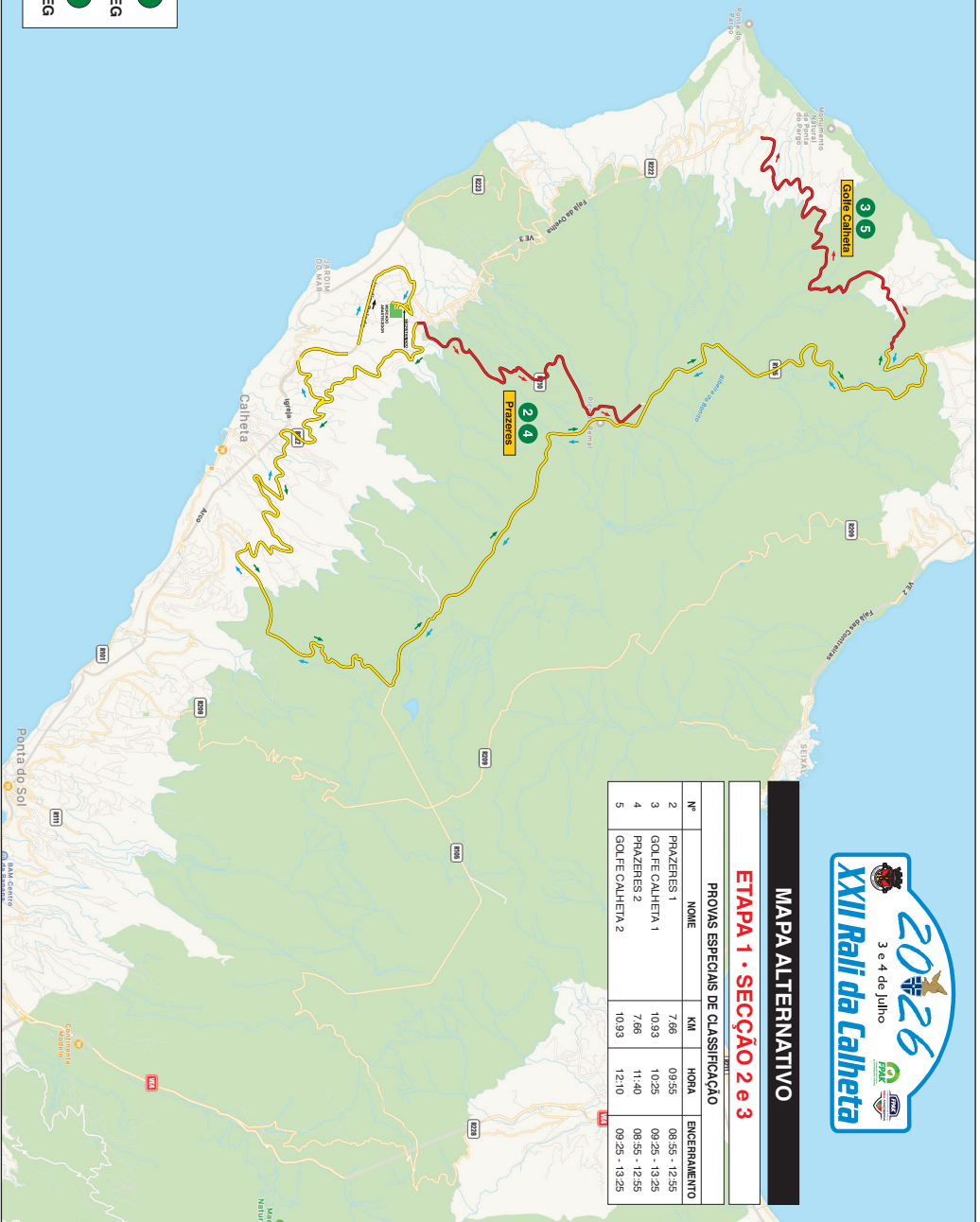

2	3
3	REG
4	5
5	REG

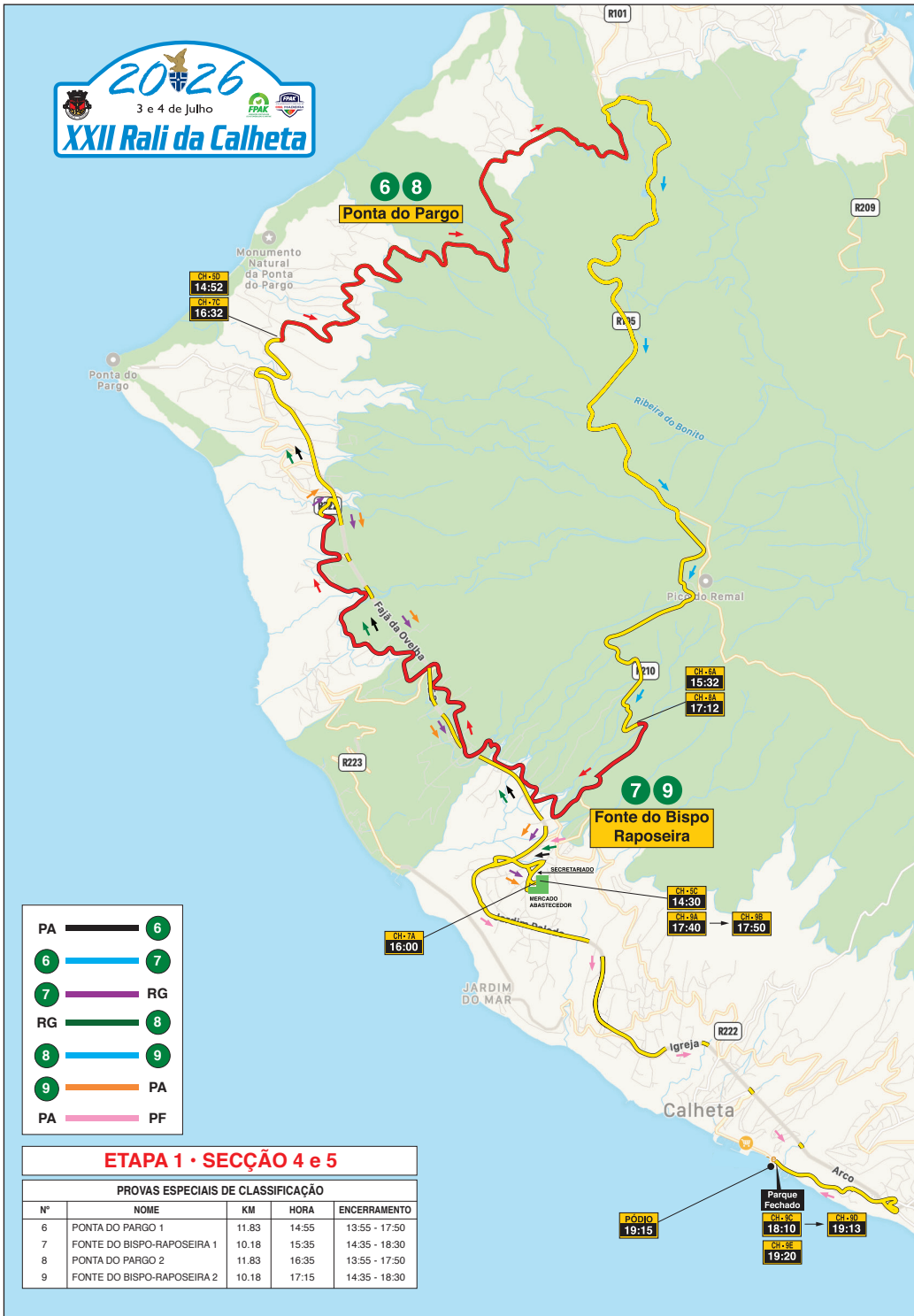

- PA — 6
- 6 — 7
- 7 — RG
- RG — 8
- 8 — 9
- 9 — PA
- PA — PF

ETAPA 1 • SECÇÃO 4 e 5

PROVAS ESPECIAIS DE CLASSIFICAÇÃO				
Nº	NOME	KM	HORA	ENCERRAMENTO
6	PONTA DO PARGO 1	11.83	14:55	13:55 - 17:50
7	FONTE DO BISPO-RAPOSEIRA 1	10.18	15:35	14:35 - 18:30
8	PONTA DO PARGO 2	11.83	16:35	13:55 - 17:50
9	FONTE DO BISPO-RAPOSEIRA 2	10.18	17:15	14:35 - 18:30

PODIO 19:15
Parque Fechado 18:10 - 19:13
 19:20



MAPA ALTERNATIVO



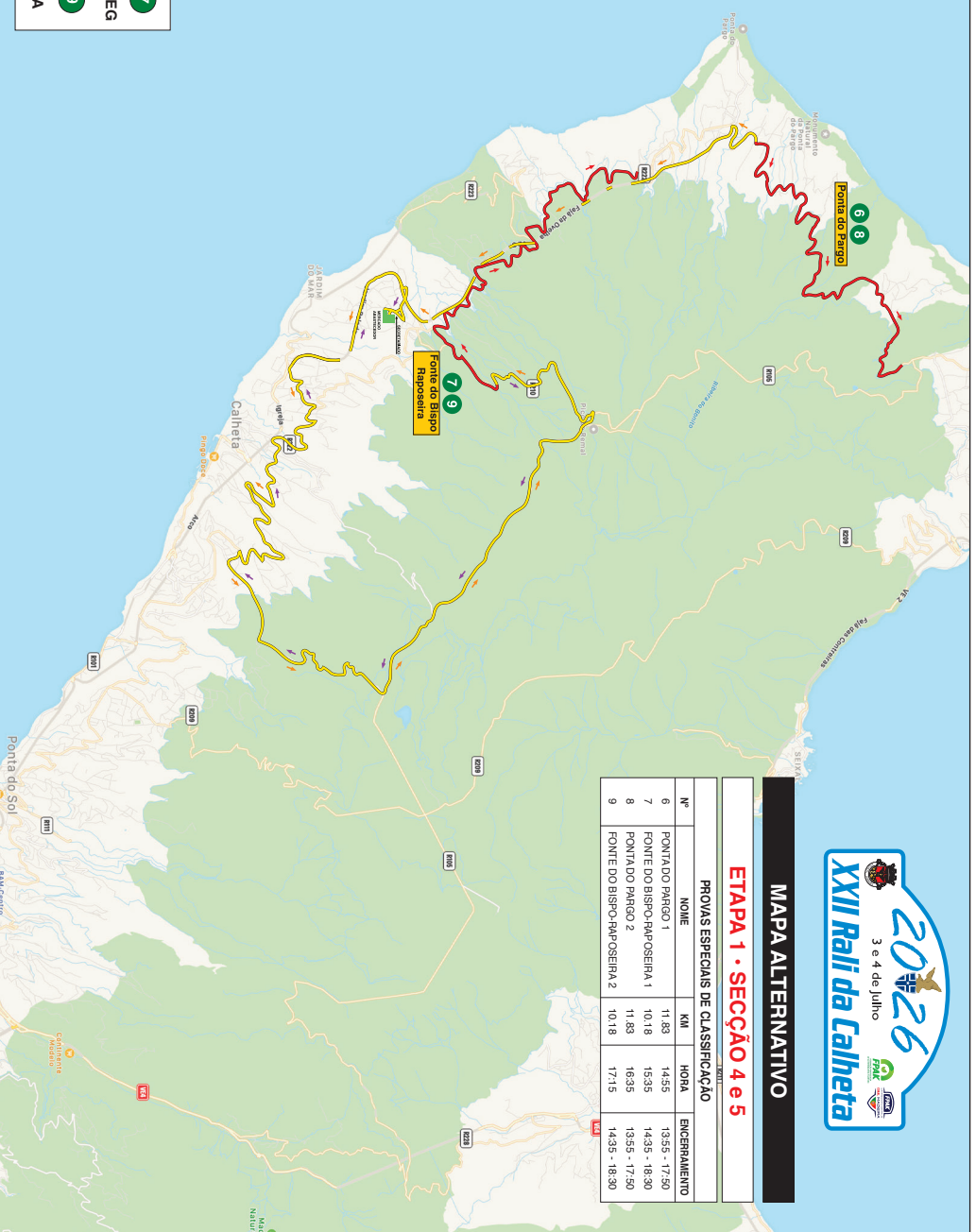

ETAPA 1 - SECÇÃO 4 e 5





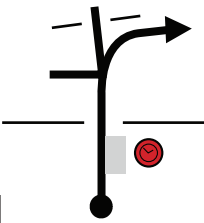

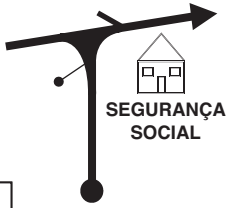
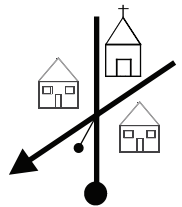
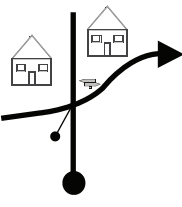

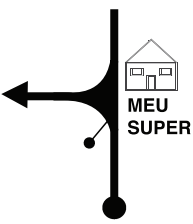

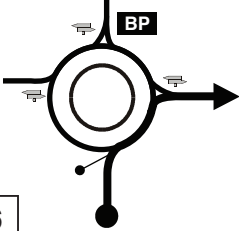

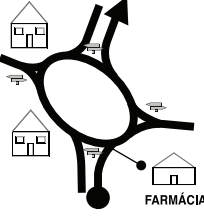

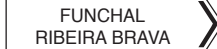

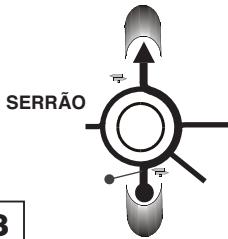

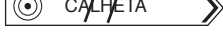

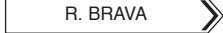

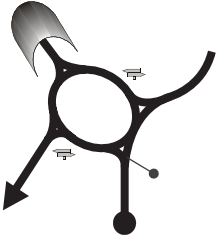
PROVAS ESPECIAIS DE CLASSIFICAÇÃO					
Nº	NOME	KM	HORA	ENCERRAMENTO	
6	PONTA DO PARGO 1	11,83	14:55	13:55 - 17:50	
7	FONTE DO BISPO-PAPOSEIRA 1	10,18	15:35	14:35 - 18:30	
8	PONTA DO PARGO 2	11,83	16:35	13:55 - 17:50	
9	FONTE DO BISPO-PAPOSEIRA 2	10,18	17:15	14:35 - 18:30	





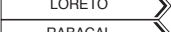
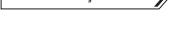
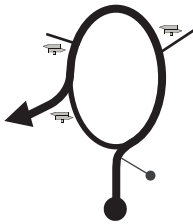
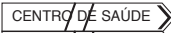

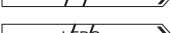
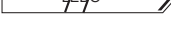

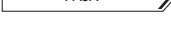

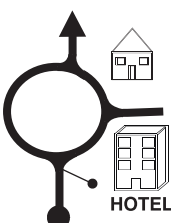
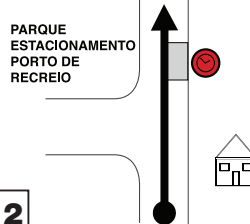

6	7
8	REG
9	PA

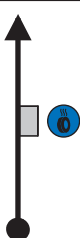
CH 0 - CAMPO FUTEBOL PRAZERES (PF)	DISTÂNCIA	ETAPA	1	Página	1
CH 0A - VILA DA CALHETA	12.08 Km	SECÇÃO	1		
Prova Especial	MÉDIA	TEMPO	22 MIN		
	32.9 Km/h				

Distância		Direção	Apênd. Prog.	Informação	Dist. to go Dist. Regr.
Total	Parcial				
0.00	0.00	 1		CAMPO DE FUTEBOL DOS PRAZERES PARQUE FECHADO - SAÍDA  <div style="border: 1px solid black; padding: 2px; display: inline-block;"> N 32°45'5.14" W 17°12'15.44" </div> 0	12.08
0.12	0.12	 2		CAMINHO DA REFERTA	11.96
0.44	0.32	 3		CAMINHO DA REFERTA CAMINHO LOMBO DA ROCHA	11.64
0.67	0.23	 4		CAMINHO LOMBO DA ROCHA <div style="border: 1px solid black; padding: 5px; display: inline-block;"> HOTEL APARTAMENTOS JARDIM ATLÂNTICO  </div>	11.41
1.12	0.45	 5		CAMINHO LOMBO DA ROCHA VE 3	10.96

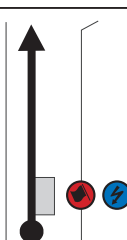
CH 0 - CAMPO FUTEBOL PRAZERES (PF)		DISTÂNCIA	ETAPA	1	Página
CH 0A - VILA DA CALHETA			12.08 Km	SECÇÃO	1
Prova Especial		MÉDIA	TEMPO		22 MIN
Distância		Direção	Informação	Dist. to go	
Total	Parcial			Dist. Regr.	
1.20	0.08	 <p>6</p>	VE 3  	10.88	
5.00	3.80	 <p>7</p>	VE 3    	7.08	
7.31	2.31	 <p>8</p>	VE 3      	4.77	
9.93	2.62	 <p>9</p>	VE 3        	2.15	
10.15	0.22	 <p>10</p>	ROTUNDA DO ARCO DA CALHETA       	1.93	
			RUA DA SERRA D'ÁGUA		

CH 0 - CAMPO FUTEBOL PRAZERES (PF)	DISTÂNCIA	ETAPA	1	Página
CH 0A - VILA DA CALHETA	12.08 Km	SECÇÃO	1	3
Prova Especial	MÉDIA	TEMPO	22 MIN	
	32.9 Km/h			

Distância		Direção	Informação	Dist. Regr.
Total	Parcial			
11.97	1.82		RUA DA SERRA D'ÁGUA	0.11
		11		
12.08	0.11		AVENIDA D. MANUEL I  N 32°43'2.64" W 17°10'10.07" 0A	0.00
		12	(0.74)	
	0.025		AVENIDA D. MANUEL I 	
		13		
	0.64		AVENIDA D. MANUEL I 	
		14		
	0.74		AVENIDA D. MANUEL I N 32°43'13.36" W 17°10'35.61"  T-1  1A  	
		15		

VILA DA CALHETA • PEC 1A - 21:00h

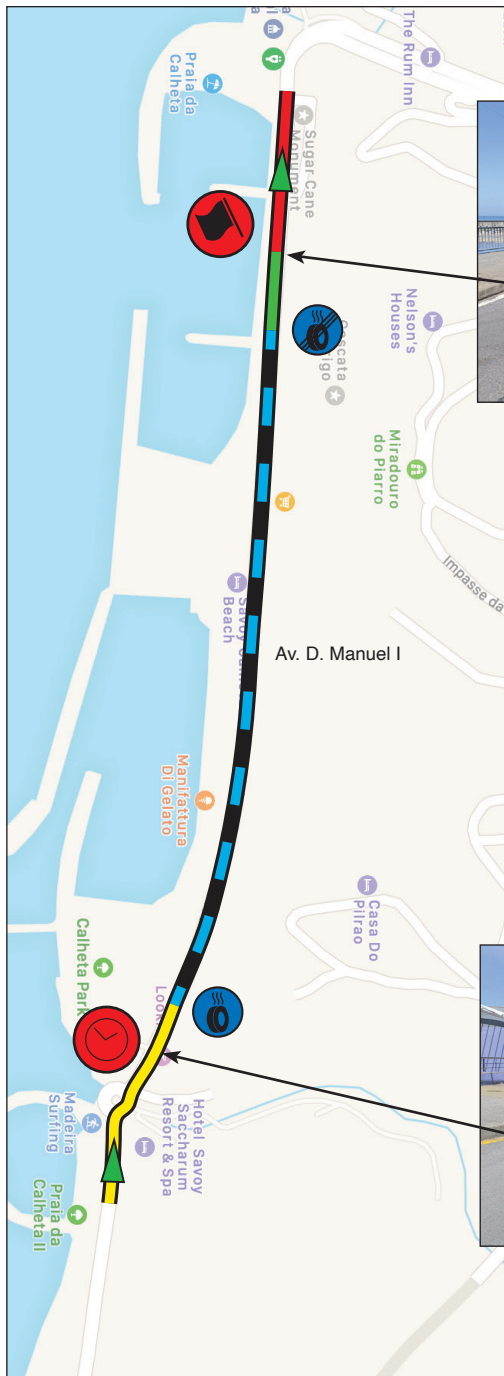

CHC ← 740 mts → P



VILA DA CALHETA • PEC 1A - 21:00h

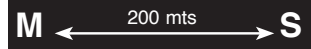
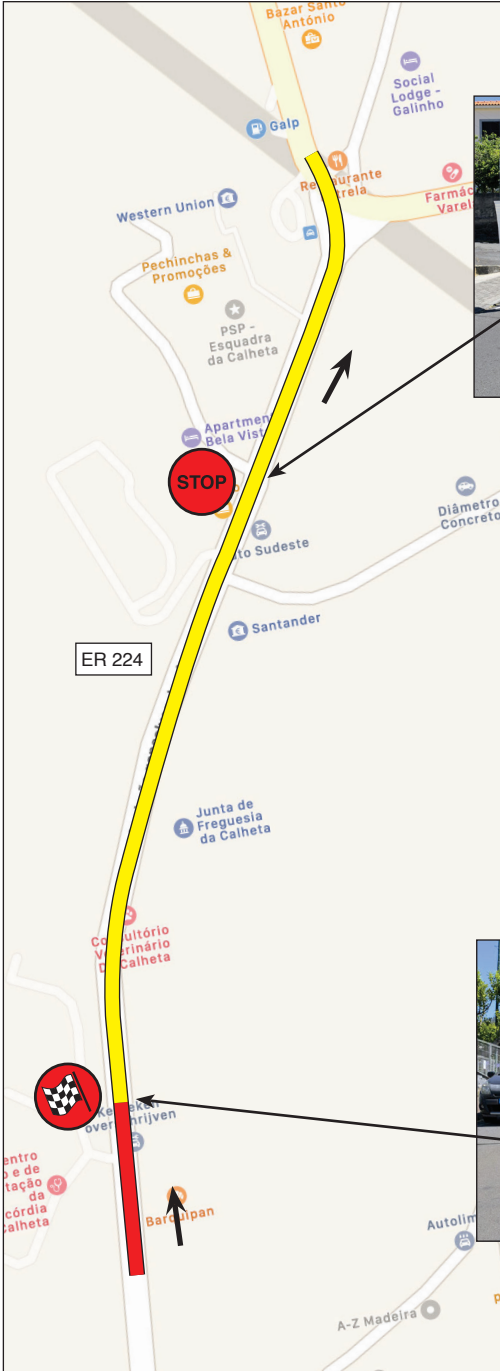







CH 1A - VILA DA CALHETA		DISTÂNCIA		ETAPA		Página	
CH 1B - VILA DA CALHETA		14.11 Km		SEÇÃO		7	
Prova Especial		1A		MÉDIA		TEMPO	
Vila da Calheta "Coral"		2.97 Km		38.5 Km/h		22 MIN	
Distância		Direção		Informação		Dist. to go Dist. Regr.	
Total	Parcial						
0.00	0.00	<div style="text-align: center;"> </div>		<p>AVENIDA D. MANUEL I</p> <p>N 32°43'13.36" W 17°10'35.61"</p> <div style="display: flex; justify-content: space-around;"> <div style="text-align: center;"> T-1 </div> <div style="text-align: center;"> 1A </div> <div style="text-align: center;"> </div> </div>		14.11	
0.18	0.18	<div style="text-align: center;"> </div>		<p>AVENIDA D. MANUEL I</p> <div style="text-align: center; font-size: 2em;">!!</div>		13.93	
1.66	1.48	<div style="text-align: center;"> </div>		<p>RUA SIMÃO GONÇALVES DA CÂMARA ER 224</p> <div style="text-align: center;"> </div>		12.45	
1.88	0.22	<div style="text-align: center;"> </div>		<p>RUA DA VARGEM</p> <div style="text-align: center; font-size: 2em;">!!</div>		12.23	
2.48	0.60	<div style="text-align: center;"> </div>		<p>RUA DA VARGEM</p> <div style="text-align: center;"> </div>		11.63	

CH 1A - VILA DA CALHETA		DISTÂNCIA		ETAPA		1		Página	
CH 1B - VILA DA CALHETA		14.11 Km		SECÇÃO		1		8	
Prova Especial		1A		MÉDIA		TEMPO		22 MIN	
Vila da Calheta "Coral"		2.97 Km		38.5 Km/h					
Distância		Direção		Informação		Dist. Regr.			
Total	Parcial								
2.97	0.49	6		 1A	RUA SIMÃO GONÇALVES DA CÂMARA ER 224 N 32°43'39.52" W 17°10'46.12"	11.14			
3.17	0.20	7		 1A T-2	RUA SIMÃO GONÇALVES DA CÂMARA ER 224 N 32°43'45.31" W 17°10'42.59"	10.94			
3.28	0.11	8		 RABACAL FARMÁCIA HOSPITAL DA CALHETA EST. DA CALHETA	RUA SIMÃO GONÇALVES DA CÂMARA ER 224 ER 222	10.83			
5.53	2.25	9		 CENTRO DE SAÚDE ESTREITO DA CALHETA JARDIM DO MAR	ER 222 ER 223	8.58			
6.99	1.46	10		 PORTO MONIZ PONTA DO PARÇO PRAZERES JARDIM DO MAR PAU DO AR FARMÁCIA FUNCHAL RIBEIRA BRAVA CALHETA	ER 223 VE 3	7.12			

CH 1A - VILA DA CALHETA		DISTÂNCIA		ETAPA		1		Página	
CH 1B - VILA DA CALHETA		14.11 Km		SEÇÃO		1		9	
Prova Especial		1A		MÉDIA		TEMPO		22 MIN	
Vila da Calheta "Coral"		2.97 Km		38.5 Km/h					
Distância		Direção		Informação		Dist. Regr.			
Total	Parcial								
9.34	2.35			VE 3 		4.77			
11.96	2.62			VE 3 		2.15			
12.18	0.22					1.93			
14.00	1.82			RUA DA SERRA D'ÁGUA RUA DA SERRA D'ÁGUA 		0.11			
14.11	0.11			AVENIDA D. MANUEL I 		0.00			

CH 1A - VILA DA CALHETA	DISTÂNCIA	ETAPA	1	Página
CH 1B - VILA DA CALHETA	14.11 Km	SECÇÃO	1	10
Prova Especial Vila da Calheta "Coral"	1A 2.97 Km	MÉDIA	38.5 Km/h	TEMPO 22 MIN

Distância		Direção	Alinh. Prog.	Informação	Dist. Regr.
Total	Parcial				
	0.025			AVENIDA D. MANUEL I  <div style="border: 1px solid black; padding: 5px; display: inline-block;"> INÍCIO DE ZONA DE AQUECIMENTO DE PNEUS </div>	
	16				
	0.64			AVENIDA D. MANUEL I  <div style="border: 1px solid black; padding: 5px; display: inline-block;"> FIM DE ZONA DE AQUECIMENTO DE PNEUS </div>	
	17				
	0.74			AVENIDA D. MANUEL I <div style="border: 1px solid black; padding: 2px; display: inline-block;"> N 32°43'13.36" W 17°10'35.61" </div>  T-1 <div style="border: 1px solid black; padding: 5px; display: inline-block; margin-left: 20px;">  1B <div style="border: 1px solid black; padding: 5px; display: inline-block; margin-left: 20px;">   </div> </div>	
	18				

NOTAS

VILA DA CALHETA

Segurança na PEC

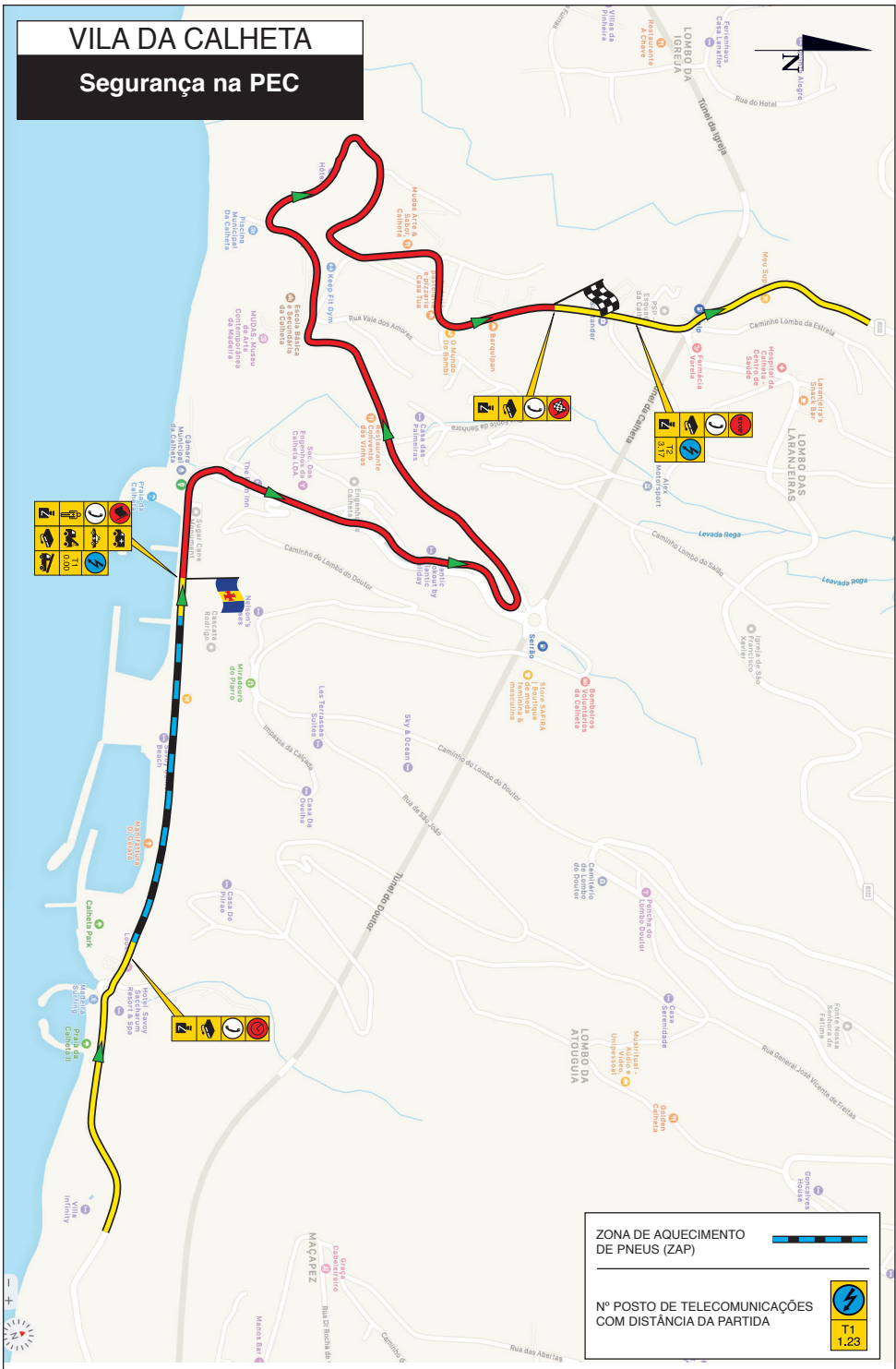

VILA DA CALHETA • PEC 1B - 21:25h

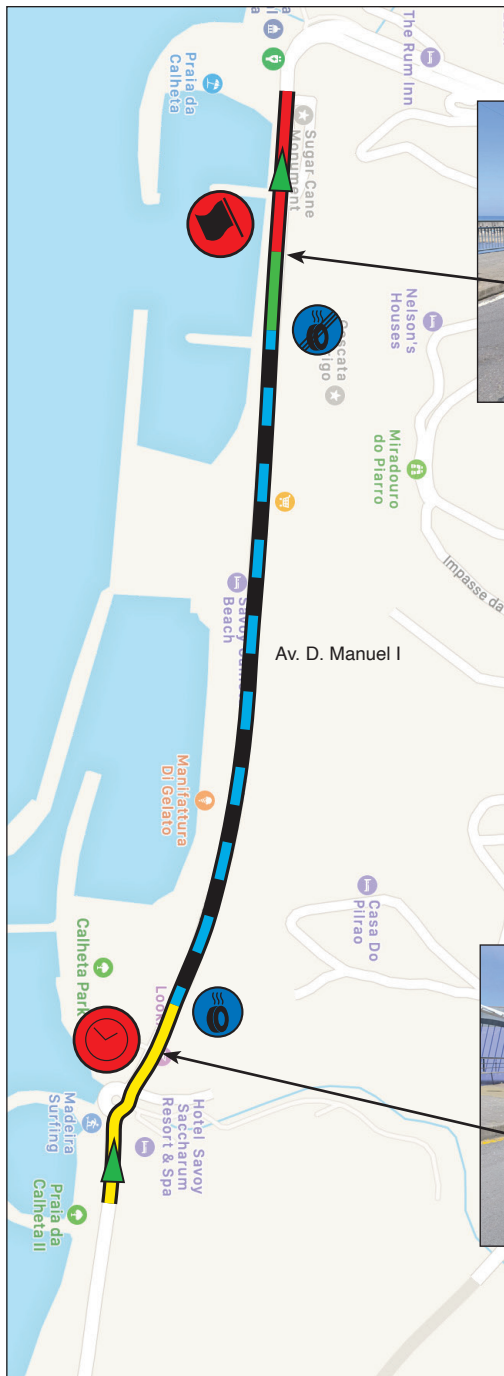

CHC ← 740 mts → P



VILA DA CALHETA • PEC 1B - 21:25h

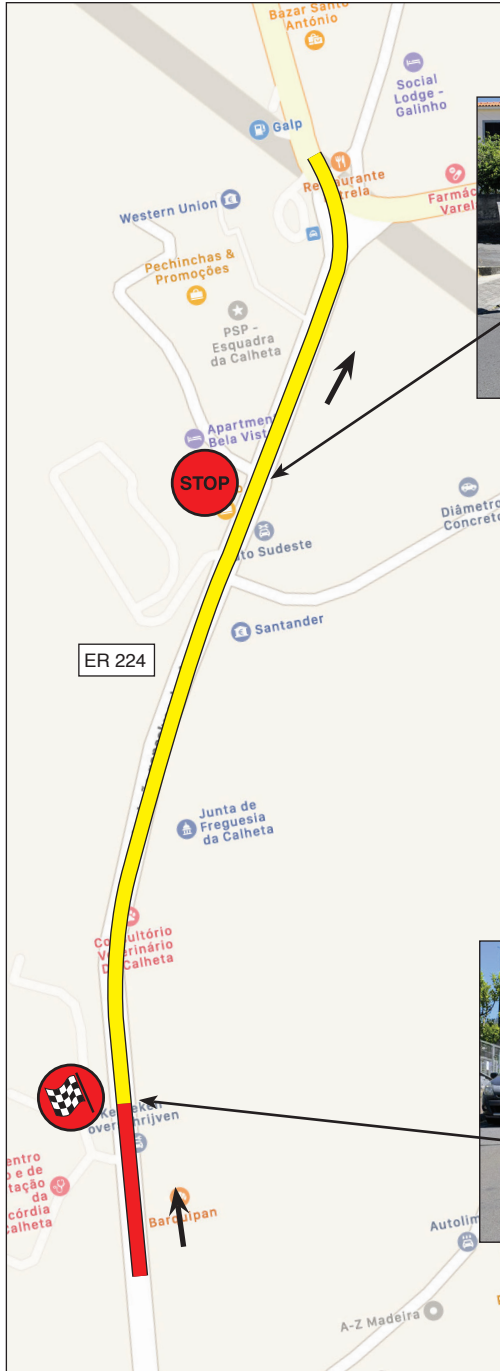





CH 1B - VILA DA CALHETA		DISTÂNCIA	ETAPA	1	Página 15	
CH 1C - C. F. PRAZERES/M. ABASTECEDOR - PA (A)			11.67 Km	SECÇÃO		1
Prova Especial Vila da Calheta "Coral"		1B 2.97 Km	MÉDIA	38.9 Km/h	TEMPO	18 MIN

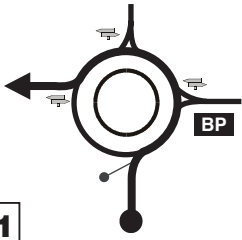
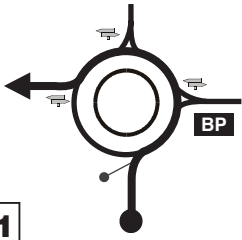
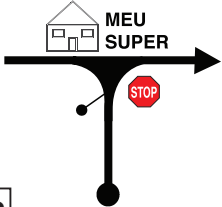
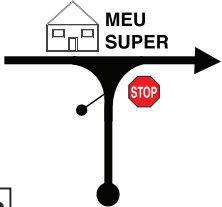

Distância		Direção	Informação	Dist. to go Dist. Regr.
Total	Parcial			
0.00	0.00	<div style="text-align: center;"> <p>1</p> <p style="text-align: right;">2.97</p> </div>	<p>AVENIDA D. MANUEL I</p> <div style="border: 1px solid black; padding: 2px; margin-bottom: 5px;"> <p>N 32°43'13.36"</p> <p>W 17°10'35.61"</p> </div> <div style="display: flex; justify-content: space-around; align-items: center;"> <div style="text-align: center;"> <p>T-1</p> </div> <div style="text-align: center;"> <p>1B</p> </div> <div style="text-align: center;"> </div> </div>	11.67
0.18	0.18	<div style="text-align: center;"> <p>2</p> <p style="text-align: right;">2.79</p> </div>	<p>AVENIDA D. MANUEL I</p> <div style="text-align: center; font-size: 2em; margin: 10px 0;">!!</div> <p>RUA SIMÃO GONÇALVES DA CÂMARA</p>	11.49
1.66	1.48	<div style="text-align: center;"> <p>3</p> <p style="text-align: right;">1.31</p> </div>	<p>RUA SIMÃO GONÇALVES DA CÂMARA ER 224</p> <div style="border: 1px solid black; padding: 5px; margin: 10px 0; text-align: center;"> <p>PAVILHÃO GIMNODESPORTIVO</p> </div> <p>RUA DA VARGEM</p>	10.01
1.88	0.22	<div style="text-align: center;"> <p>4</p> <p style="text-align: right;">1.09</p> </div>	<p>RUA DA VARGEM</p> <div style="text-align: center; font-size: 2em; margin: 10px 0;">!!</div>	9.79
2.48	0.60	<div style="text-align: center;"> <p>5</p> <p style="text-align: right;">0.49</p> </div>	<p>RUA DA VARGEM</p> <div style="text-align: center; margin: 10px 0;"> </div> <p>RUA SIMÃO GONÇALVES DA CÂMARA ER 224</p>	9.19

1B

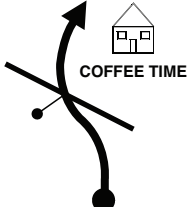
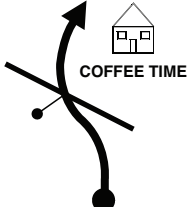
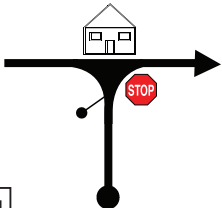
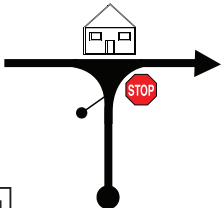
CH 1B - VILA DA CALHETA		DISTÂNCIA		ETAPA		1		Página	
CH 1C - C. F. PRAZERES/M. ABASTECEDOR - PA (A)		11.67 Km		SECÇÃO		1		16	
Prova Especial		1B		MÉDIA		TEMPO		18 MIN	
Vila da Calheta "Coral"		2.97 Km		38.9 Km/h					
Distância		Direção		Informação				Dist. Regr.	
Total	Parcial								
2.97	0.49	6		0.00	RUA SIMÃO GONÇALVES DA CÂMARA ER 224		N 32°43'39.52" W 17°10'46.12"	1B	8.70
3.17	0.20	7			RUA SIMÃO GONÇALVES DA CÂMARA ER 224		N 32°43'45.31" W 17°10'42.59"	1B	8.50
3.28	0.11	8			RUA SIMÃO GONÇALVES DA CÂMARA ER 224		RABAÇAL FARMÁCIA HOSPITAL DA CALHETA		8.39
5.53	2.25	9			ER 222		ESTREITO DA CALHETA		6.14
6.99	1.46	10			ER 223		PONTA DO PARGO PRAZERES		4.68
					VE 3				

1B

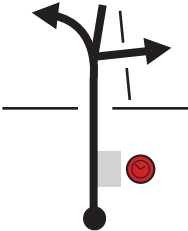





CH 1B - VILA DA CALHETA		DISTÂNCIA		ETAPA		Página																			
CH 1C - C. F. PRAZERES/M. ABASTECEDOR - PA (A)		11.67 Km		SEÇÃO		17																			
Prova Especial		1B		MÉDIA		TEMPO																			
Vila da Calheta "Coral"		2.97 Km		38.9 Km/h		18 MIN																			
Distância		Direção	Apênd. Prog.	Informação		Dist. Regr.																			
Total	Parcial																								
10.78	3.79	 11		 VE 3 <table border="1" data-bbox="605 252 822 496"> <tr><td>ÁREA DE SERVIÇO</td><td>→</td></tr> <tr><td>PORTO MONIZ PONTA DO PARGO</td><td>→</td></tr> <tr><td>PRAZERES</td><td>→</td></tr> <tr><td>PRAZERES LOMBO DA ROCHA</td><td>→</td></tr> <tr><td>HOTEL</td><td>→</td></tr> </table> 0.89	ÁREA DE SERVIÇO	→	PORTO MONIZ PONTA DO PARGO	→	PRAZERES	→	PRAZERES LOMBO DA ROCHA	→	HOTEL	→											
ÁREA DE SERVIÇO	→																								
PORTO MONIZ PONTA DO PARGO	→																								
PRAZERES	→																								
PRAZERES LOMBO DA ROCHA	→																								
HOTEL	→																								
10.93	0.15	 12		 VE 3  0.74																					
11.35	0.42	 13		 0.32																					
11.49	0.14	 14		 TRAVESSA DA FIGUEIRA <table border="1" data-bbox="598 1086 956 1214"> <tr><td>ESCOLA</td><td>→</td><td>JUNTA FREGUESIA</td><td>→</td></tr> <tr><td>MERCADO ABASTECEDOR</td><td>→</td><td>CENTRO DE DIA</td><td>→</td></tr> <tr><td>←</td><td>IGREJA</td><td>CENTRO DE SAÚDE</td><td>→</td></tr> <tr><td>←</td><td>QTA. PEDAGÓGICA</td><td>SEGURANÇA SOCIAL</td><td>→</td></tr> <tr><td>←</td><td>CLUBE DESPORTIVO</td><td>ZONA DESPORTIVA</td><td>→</td></tr> </table> 0.18	ESCOLA	→	JUNTA FREGUESIA	→	MERCADO ABASTECEDOR	→	CENTRO DE DIA	→	←	IGREJA	CENTRO DE SAÚDE	→	←	QTA. PEDAGÓGICA	SEGURANÇA SOCIAL	→	←	CLUBE DESPORTIVO	ZONA DESPORTIVA	→	
ESCOLA	→	JUNTA FREGUESIA	→																						
MERCADO ABASTECEDOR	→	CENTRO DE DIA	→																						
←	IGREJA	CENTRO DE SAÚDE	→																						
←	QTA. PEDAGÓGICA	SEGURANÇA SOCIAL	→																						
←	CLUBE DESPORTIVO	ZONA DESPORTIVA	→																						
11.58	0.09	 15		 CAMINHO DA REFERTA <table border="1" data-bbox="667 1350 885 1437"> <tr><td>MERCADO ABASTECEDOR</td><td>↑</td></tr> <tr><td>←</td><td>ESCOLA</td></tr> <tr><td>←</td><td>ZONA DESPORTIVA</td></tr> </table> 0.09	MERCADO ABASTECEDOR	↑	←	ESCOLA	←	ZONA DESPORTIVA															
MERCADO ABASTECEDOR	↑																								
←	ESCOLA																								
←	ZONA DESPORTIVA																								
				IMPASSE DO CAMPO																					

CH 1B - VILA DA CALHETA		DISTÂNCIA		ETAPA	1	Página	18
CH 1C - C. F. PRAZERES/M. ABASTECEDOR - PA (A)		11.67 Km		SECÇÃO	1		
Prova Especial Vila da Calheta "Coral"		1B 2.97 Km	MÉDIA 38.9 Km/h	TEMPO		18 MIN	
Distância		Direção	Alpha Prog	Informação		Dist. Regr.	
Total	Parcial						
11.67	0.09			C. F. PRAZERES / M. ABASTECEDOR PARQUE DE ASSISTÊNCIAS ENTRADA		0.00	
	16			 N 32°45'4.51" W 17°12'17.31" 1C			

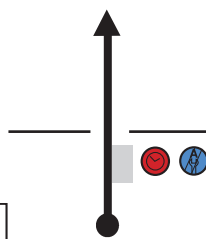

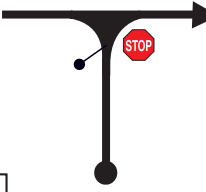
**CAMPO DE FUTEBOL DOS PRAZERES
E MERCADO ABASTECEDOR
PARQUE DE ASSISTÊNCIAS A
(45 MIN)**

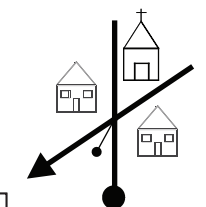
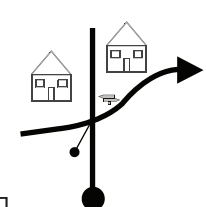

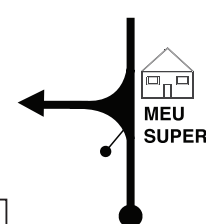
CH 1D - C. F. PRAZERES/M. ABASTECEDOR - PA (A)	DISTÂNCIA	ETAPA	1	Página
CH 1E - PORTO DE RECREIO - PF	12.22 Km	SECÇÃO	1	19
Prova Especial	MÉDIA	TEMPO	20 MIN	
		36.7 Km/h		

Distância		Direção	Informação	Dist. to go Dist. Regr.
Total	Parcial			
0.00	0.00	 <p>1</p>	<p>C. F. PRAZERES / M. ABASTECEDOR PARQUE DE ASSISTÊNCIAS SAÍDA</p>   <p>N 32°45'1.00" W 17°12'18.32"</p> <p>1D PA - A</p>	12.22
0.07	0.07	 <p>2</p>	<p>MERCADO ABASTECEDOR SAÍDA</p>  <p>CAMINHO DA REFERTA CAMINHO DA REFERTA</p>	12.15
0.52	0.45	 <p>3</p>	<p>CAMINHO LOMBO DA ROCHA CAMINHO LOMBO DA ROCHA</p>	11.70
0.75	0.23	 <p>4</p>	<p>CAMINHO LOMBO DA ROCHA</p>  <p>HOTEL APARTAMENTOS JARDIM ATLÂNTICO</p>	11.47
1.20	0.45	 <p>5</p>	<p>CAMINHO LOMBO DA ROCHA</p> <p>VE 3</p>	11.02

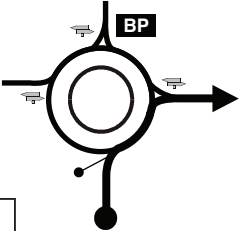
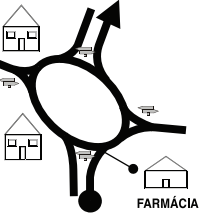
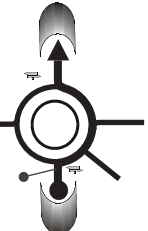
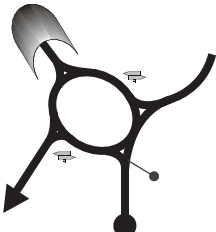
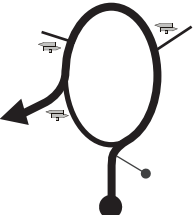
CH 1D - C. F. PRAZERES/M. ABASTECEDOR - PA (A)	DISTÂNCIA	ETAPA	1	Página
CH 1E - PORTO DE RECREIO - PF		12.22 Km	SECÇÃO	1
Prova Especial	MÉDIA	36.7 Km/h	TEMPO	20 MIN

Distância		Direção	Informação	Dist. to go Dist. Regr.
Total	Parcial			
1.28	0.08	 <p>6</p>	<p>VE 3</p> <p>FUNCHAL RIBEIRA BRAVA</p> <p>CALHETA</p>	10.94
5.07	3.79	 <p>7</p>	<p>VE 3</p> <p>JARDIM DO MAR PAÚL DO MAR</p> <p>FARMÁCIA</p> <p>FUNCHAL RIBEIRA BRAVA</p> <p>CALHETA</p>	7.15
7.38	2.31	<p>SERRÃO</p>  <p>8</p>	<p>VE 3</p> <p>ESTRELA</p> <p>RABAÇAL</p> <p>CALHETA</p> <p>AEROPORTO</p> <p>R. BRAVA</p> <p>FUNCHAL</p>	4.84
9.99	2.61	 <p>9</p>	<p>VE 3</p> <p>ACESSO LOCAL</p> <p>FUNCHAL</p> <p>RIBEIRA BRAVA</p> <p>MADALENA DO MAR</p> <p>AEROPORTO</p> <p>ARCO DA CALHETA</p> <p>LORETO</p> <p>RABAÇAL</p> <p>ROTUNDA DO ARCO DA CALHETA</p> <p>ROTUNDA DO ARCO DA CALHETA</p>	2.23
10.21	0.22	 <p>10</p>	<p>CENTRO DE SAÚDE</p> <p>RABAÇAL</p> <p>ARCO DA CALHETA</p> <p>LEDO</p> <p>CALHETA</p> <p>MARINA</p> <p>FAJÁ</p> <p>RUA DA SERRA D'ÁGUA</p>	2.01

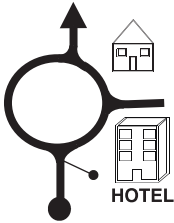
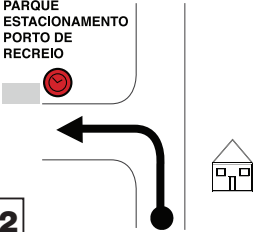
CH 1D - C. F. PRAZERES/M. ABASTECEDOR - PA (A)	DISTÂNCIA	ETAPA	1	Página
CH 1E - PORTO DE RECREIO - PF	12.22 Km	SECÇÃO	1	21
Prova Especial	MÉDIA	TEMPO	20 MIN	
	36.7 Km/h			

Distância		Direção	Apênd. Prog.	Informação	Dist. Regr.					
Total	Parcial									
12.03	1.82	 11		RUA DA SERRA D'ÁGUA AVENIDA D. MANUEL I	0.19					
12.22	0.19	PARQUE ESTACIONAMENTO PORTO DE RECREIO  12		 <table border="1" data-bbox="756 598 893 654"> <tr> <td>N</td> <td>32°43'1.78"</td> </tr> <tr> <td>W</td> <td>17°10'9.16"</td> </tr> </table> <table border="1" data-bbox="761 678 890 726"> <tr> <td>PISO 0</td> </tr> </table> 1E	N	32°43'1.78"	W	17°10'9.16"	PISO 0	0.00
N	32°43'1.78"									
W	17°10'9.16"									
PISO 0										





**PORTO DE RECREIO (SILO)
PARQUE FECHADO**

FIM 1ª SECÇÃO

CH 1F - PORTO DE RECREIO - PF	DISTÂNCIA	ETAPA	1	Página
CH 1G - C. F. PRAZERES/M. ABASTECEDOR - PA (B)	8.85 Km	SECÇÃO	2	23
Prova Especial	MÉDIA	TEMPO	15 MIN	
		35.4 Km/h		

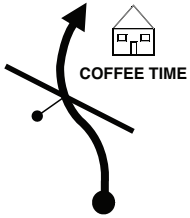
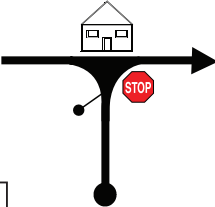
Distância		Direção	Informação	Dist. Regr.
Total	Parcial			
0.00	0.00	<p>PARQUE ESTACIONAMENTO PORTO DE RECREIO</p> <p>PISO 0</p> <p>1</p>	<p>PORTO DE RECREIO PARQUE FECHADO</p> <p>N 32°43'1.78" W 17°10'9.18"</p> <p>1F</p> <p>8.85</p>	
1.83	1.83	<p>SERRÃO</p> <p>2</p>	<p>AVENIDA D. MANUEL I</p> <p>AEROPORTO</p> <p>R. BRAVA</p> <p>FUNCHAL</p> <p>LOMBO DOUTOR</p> <p>FAJÁ DA OVELHA</p> <p>PRAZERES</p> <p>EST. CALHETA</p> <p>7.02</p>	
4.16	2.33	<p>FARMÁCIA</p> <p>3</p>	<p>VE 3</p> <p>VE 3</p> <p>EST. DA CALHETA</p> <p>PORTO MONIZ</p> <p>PTA. DO PARGO</p> <p>PRAZERES</p> <p>4.69</p>	
7.97	3.81	<p>BP</p> <p>4</p>	<p>VE 3</p> <p>ÁREA DE SERVIÇO</p> <p>PORTO MONIZ</p> <p>PONTA DO PARGO</p> <p>PRAZERES</p> <p>PRAZERES</p> <p>LOMBO DA ROCHA</p> <p>HOTEL</p> <p>0.88</p>	
8.13	0.16	<p>MEU SUPER</p> <p>STOP</p> <p>5</p>	<p>VE 3</p> <p>CAMINHO LOMBO DA ROCHA</p> <p>0.72</p>	



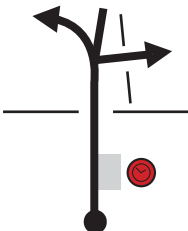



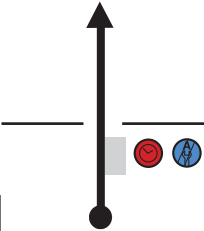

CH 1F - PORTO DE RECREIO - PF	DISTÂNCIA 8.85 Km	ETAPA	1	Página
CH 1G - C. F. PRAZERES/M. ABASTECEDOR - PA (B)		SECÇÃO	2	24
Prova Especial	MÉDIA	35.4 Km/h	TEMPO	15 MIN

Distância		Direção	Informação	Dist. Regr.										
Total	Parcial													
8.55	0.42	 <p>6</p>	CAMINHO LOMBO DA ROCHA TRAVESSA DA FIGUEIRA TRAVESSA DA FIGUEIRA <table border="1" data-bbox="537 571 896 699"> <tr> <td>ESCOLA →</td> <td>JUNTA FREGUESIA →</td> </tr> <tr> <td>MERCADO ABASTECEDOR →</td> <td>CENTRO DE DIA →</td> </tr> <tr> <td>← IGREJA</td> <td>CENTRO DE SAÚDE →</td> </tr> <tr> <td>← QTA. PEDAGÓGICA</td> <td>SEGURANÇA SOCIAL →</td> </tr> <tr> <td>← CLUBE DESPORTIVO</td> <td>ZONA DESPORTIVA →</td> </tr> </table>	ESCOLA →	JUNTA FREGUESIA →	MERCADO ABASTECEDOR →	CENTRO DE DIA →	← IGREJA	CENTRO DE SAÚDE →	← QTA. PEDAGÓGICA	SEGURANÇA SOCIAL →	← CLUBE DESPORTIVO	ZONA DESPORTIVA →	0.30
ESCOLA →	JUNTA FREGUESIA →													
MERCADO ABASTECEDOR →	CENTRO DE DIA →													
← IGREJA	CENTRO DE SAÚDE →													
← QTA. PEDAGÓGICA	SEGURANÇA SOCIAL →													
← CLUBE DESPORTIVO	ZONA DESPORTIVA →													
8.69	0.14	 <p>7</p>	CAMINHO DA REFERTA CAMINHO DA REFERTA <table border="1" data-bbox="610 829 828 925"> <tr> <td>MERCADO ABASTECEDOR ↑</td> </tr> <tr> <td>← ESCOLA</td> </tr> <tr> <td>← ZONA DESPORTIVA</td> </tr> </table>	MERCADO ABASTECEDOR ↑	← ESCOLA	← ZONA DESPORTIVA	0.08							
MERCADO ABASTECEDOR ↑														
← ESCOLA														
← ZONA DESPORTIVA														
8.77	0.08	 <p>8</p>	IMPASSE DO CAMPO C. F. PRAZERES / M. ABASTECEDOR PARQUE DE ASSISTÊNCIAS ENTRADA <table border="1" data-bbox="599 1133 840 1268"> <tr> <td></td> <td>N 32°45'4.51"</td> </tr> <tr> <td></td> <td>W 17°12'17.31"</td> </tr> <tr> <td>1G</td> <td></td> </tr> </table>		N 32°45'4.51"		W 17°12'17.31"	1G		0.00				
	N 32°45'4.51"													
	W 17°12'17.31"													
1G														
8.85	0.08	 <p>9</p>												

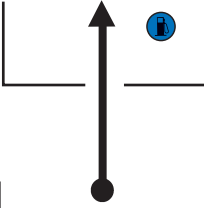

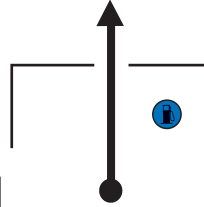
**CAMPO DE FUTEBOL DOS PRAZERES
E MERCADO ABASTECEDOR
PARQUE DE ASSISTÊNCIAS B
(15 MIN)**

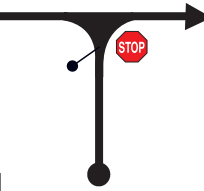
CH 1H - C. F. PRAZERES/M. ABASTECEDOR - PA (B)	DISTÂNCIA	ETAPA	1	Página
CH 1I - PRAZERES	9.96 Km	SECÇÃO	2	25
Prova Especial	MÉDIA	TEMPO	22 MIN	
				27.2 Km/h

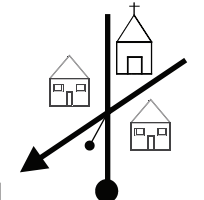
Distância		Direção	Informação	Dist. to go Dist. Regr.
Total	Parcial			
0.00	0.00		C. F. PRAZERES / M. ABASTECEDOR PARQUE DE ASSISTÊNCIAS SAÍDA  1H  PA - B <div style="border: 1px solid black; padding: 2px; display: inline-block;"> N 32°45'1.00" W 17°12'18.32" </div>	9.96
0.03	0.03		MERCADO ABASTECEDOR REABASTECIMENTO (INÍCIO)  <div style="border: 1px solid black; padding: 2px; display: inline-block;"> N 32°45'1.40" W 17°12'19.43" </div>	9.93
0.06	0.03		MERCADO ABASTECEDOR REABASTECIMENTO (SAÍDA)  <div style="border: 1px solid black; padding: 2px; display: inline-block;"> N 32°45'1.72" W 17°12'20.44" </div>	9.90
0.07	0.01		MERCADO ABASTECEDOR SAÍDA 	9.89
0.52	0.45		CAMINHO DA REFERTA CAMINHO DA REFERTA CAMINHO LOMBO DA ROCHA	9.44

CH 1H - C. F. PRAZERES/M. ABASTECEDOR - PA (B)	DISTÂNCIA	ETAPA	1	Página
CH 1I - PRAZERES		9.96 Km	SECÇÃO	2
Prova Especial	MÉDIA	27.2 Km/h	TEMPO	22 MIN

Distância		Direção	Informação	Dist. to go Dist. Regr.
Total	Parcial			
0.75	0.23	<p>6</p>	CAMINHO LOMBO DA ROCHA 	9.21
1.20	0.45	<p>7</p>	CAMINHO LOMBO DA ROCHA VE 3	8.76
1.28	0.08	<p>8</p>	VE 3 	8.68
5.07	3.79	<p>9</p>	VE 3 ER 223	4.89
6.60	1.53	<p>10</p>	ER 223 ER 222	3.36

CH 1H - C. F. PRAZERES/M. ABASTECEDOR - PA (B)	DISTÂNCIA	ETAPA	1	Página
CH 1I - PRAZERES	9.96 Km	SECÇÃO	2	27
Prova Especial	MÉDIA	TEMPO	22 MIN	
	27.2 Km/h			

Distância		Direção	Informação	Dist. Regr.
Total	Parcial			
9.02	2.42		ER 222	0.94
		11		
9.96	0.94		ER 222 N 32°45'14.52" W 17°11'35.69" 11	0.00
		12	(1.12)	
	0.025		ER 222 INÍCIO DE ZONA DE AQUECIMENTO DE PNEUS	
		13		
	1.02		ER 222 FIM DE ZONA DE AQUECIMENTO DE PNEUS	
		14		
	1.12		ER 222 N 32°45'17.26" W 17°12'4.83" T-1 2 	
		15		

PRAZERES

Segurança na PEC



ZONA DE AQUECIMENTO DE PNEUS (ZAP) 

Nº POSTO DE TELECOMUNICAÇÕES COM DISTÂNCIA DA PARTIDA 

PRAZERES • PEC 2 - 09:55h

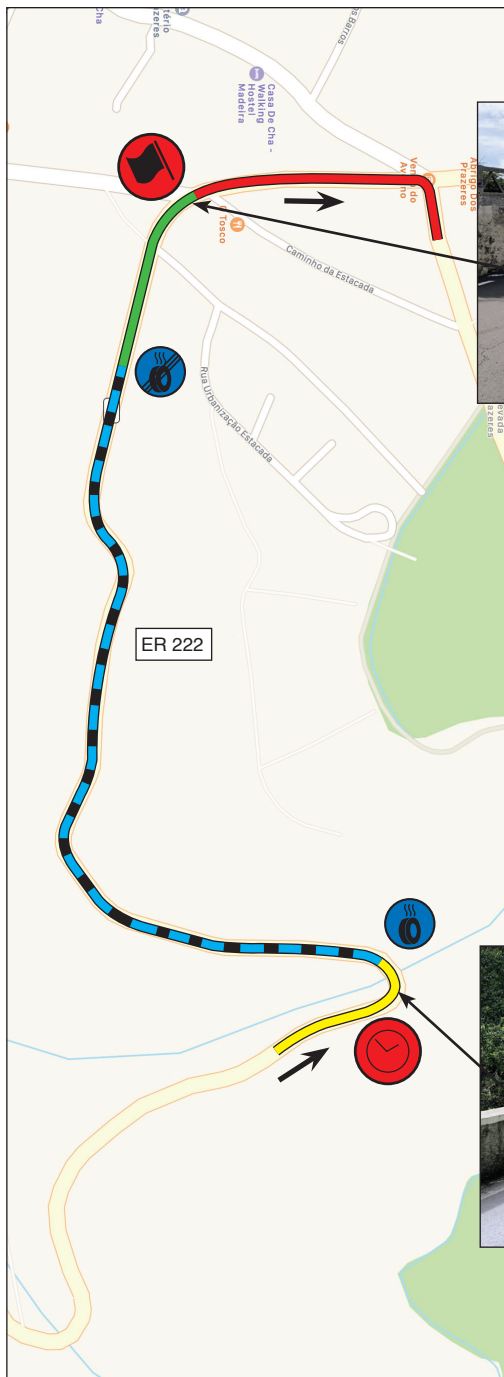

CHC ← 1120 mts → P



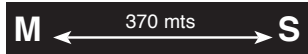
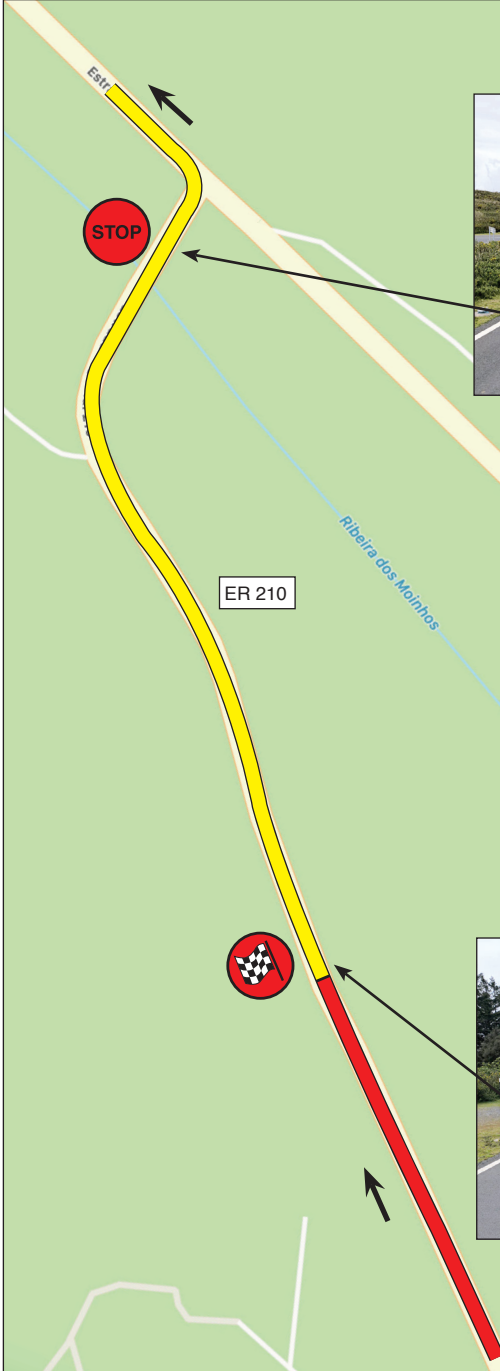





CH 11 - PRAZERES		DISTÂNCIA		ETAPA		Página	
CH 2A - SANTA		17.29 Km		SEÇÃO		31	
Prova Especial		2		MÉDIA		TEMPO	
Prazeres 1		7.66 Km		38.4 Km/h		27 MIN	
Distância		Direção		Informação		Dist. to go Dist. Regr.	
Total	Parcial						
0.00	0.00	<p>1 7.66</p>		ER 222 N 32°45'17.26" W 17°12'4.83" 		17.29	2
0.15	0.15	<p>2 7.51</p>		ER 222 		17.14	
4.12	3.97	<p>3 3.54</p>		ER 210 N 32°46'37.64" W 17°11'20.44"		13.17	
6.70	2.58	<p>4 0.96</p>		E.R. 210 		10.59	
7.66	0.96	<p>5 0.00</p>		E.R. 210 N 32°47'37.30" W 17°10'54.73" 2		9.63	

CH 11 - PRAZERES	DISTÂNCIA	ETAPA	1	Página
CH 2A - SANTA	17.29 Km	SECÇÃO	2	32
Prova Especial <i>Prazeres 1</i>	7.66 Km	MÉDIA	38.4 Km/h	TEMPO
				27 MIN

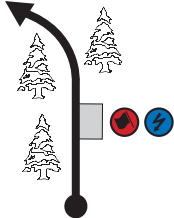
Distância		Direção	Informação	Dist. to go Dist. Repr.
Total	Parcial			
8.03	0.37		PORTO MONIZ PAÚL DA SERRA CANHAS ER 210 T-3 2 ER 105 N 32°47'46.74" W 17°11'2.18"	9.26
17.16	9.13		ER 105 ACHADAS DA CRUZ PORTO MONIZ 7 63 FUNCHAL TELEFÉRICO ER 101	0.13
17.29	0.13		ER 101 N 32°50'41.19" W 17°11'38.51" 2A (0.98)	0.00
	0.025		ER 101 INÍCIO DE ZONA DE AQUECIMENTO DE PNEUS	
	0.88		ER 101 FIM DE ZONA DE AQUECIMENTO DE PNEUS	

2

CH 11 - PRAZERES		DISTÂNCIA		ETAPA	1	Página	33
CH 2A - SANTA		17.29 Km		SECÇÃO	2		
Prova Especial		2	MÉDIA	TEMPO		27 MIN	
<i>Prazeres 1</i>		7.66 Km	38.4 Km/h				
Distância		Direção	Apênd. Prog.	Informação		Dist. Regr.	
Total	Parcial						
	0.98			ER 101	<div style="border: 1px solid black; padding: 2px;"> N 32°50'24.81" W 17°11'39.77" </div>   <div style="border: 1px solid black; padding: 2px; width: fit-content; margin: 2px auto;">3</div>  		
	11						

GOLFE CALHETA

Segurança na PEC

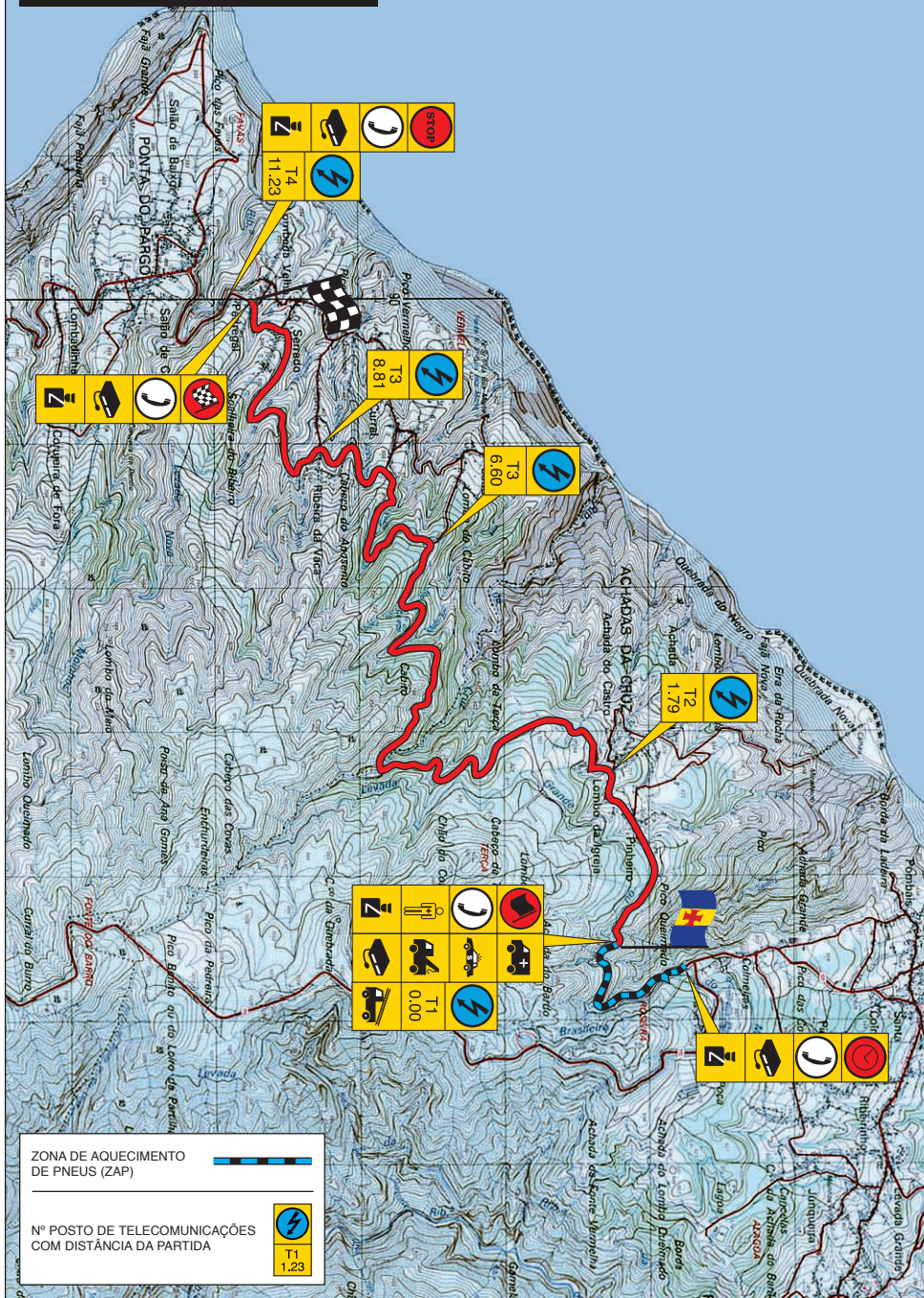







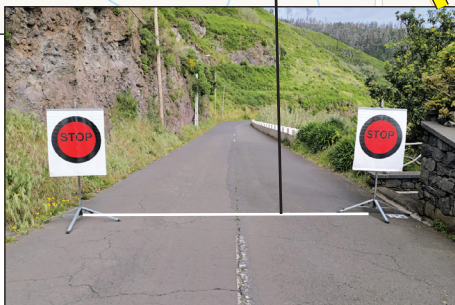
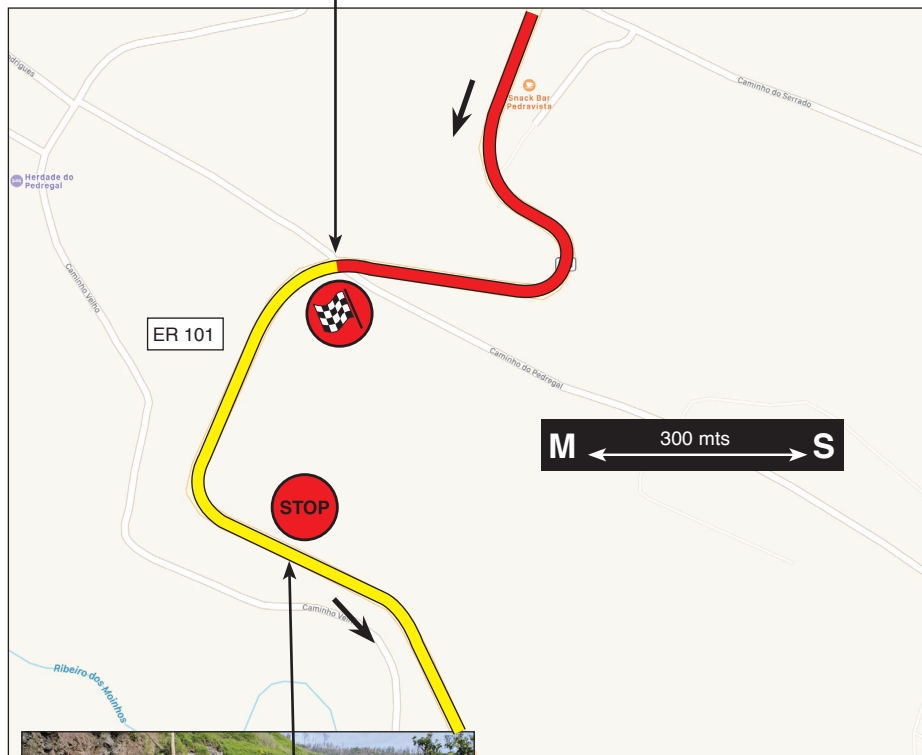



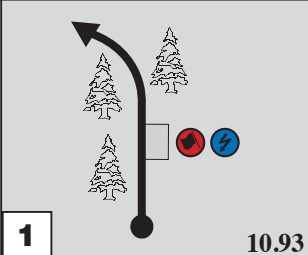

GOLFE CALHETA • PEC 3 - 10:25h

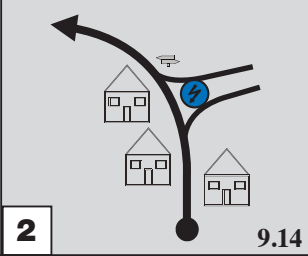

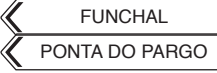
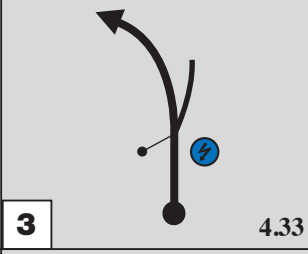

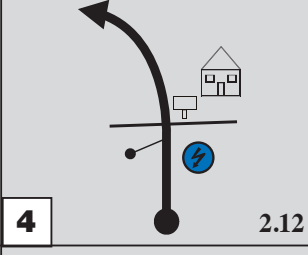
GOLFE CALHETA • PEC 3 - 10:25h

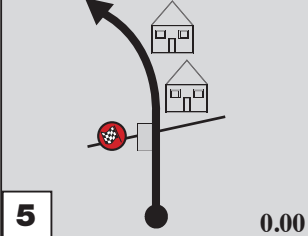





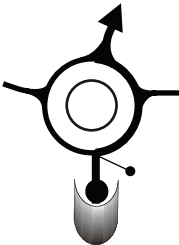
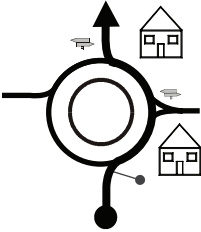
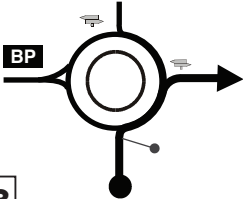
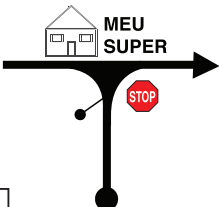

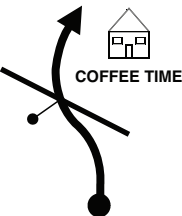
CH 2A - SANTA	DISTÂNCIA	ETAPA	1	Página
CH 3A - C. F. PRAZERES/M. ABASTECEDOR (REAG.)	21.61 Km	SECÇÃO	2	37
Prova Especial <i>Golfe Calheta 1</i>	3 10.93 Km	MÉDIA	37.0 Km/h	TEMPO
				35 MIN

Distância		Direção	Informação	Dist. to go Dist. Regr.
Total	Parcial			
0.00	0.00	 <p>1 10.93</p>	ER 101  T-1  3   N 32°50'24.81" W 17°11'39.77"	21.61
1.79	1.79	 <p>2 9.14</p>	ER 101   T-2  N 32°50'24.84" W 17°12'31.85"	19.82
6.60	4.81	 <p>3 4.33</p>	ER 101  T-3  N 32°49'43.29" W 17°13'29.84"	15.01
8.81	2.21	 <p>4 2.12</p>	ER 101  T-4  N 32°49'18.39" W 17°13'55.38"	12.80
10.93	2.12	 <p>5 0.00</p>	ER 101  3 N 32°49'3.09" W 17°14'32.54"	10.68

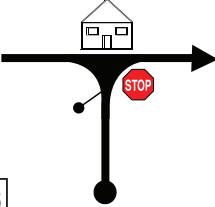
CH 2A - SANTA		DISTÂNCIA		ETAPA	1	Página
CH 3A - C. F. PRAZERES/M. ABASTECEDOR (REAG.)		21.61 Km		SECÇÃO	2	38
Prova Especial		3		MÉDIA	TEMPO	
Golfe Calheta I		10.93 Km		37.0 Km/h		35 MIN
Distância		Direção	Informação	Dist. to go		
Total	Parcial			Dist. Repr.		
11.23	0.30		ER 101 N 32°48'56.56" W 17°14'34.04" T-5	10.38		
12.18	0.95		ER 101 SRA. DO AMPARO FUNCHAL CALHETA FAJÃ DA OVELHA VE 3 VE 3	9.43		
12.96	0.78		FUNCHAL CALHETA FAJÃ DA OVELHA	8.65		
13.76	0.80		VE 3 SRA. DO AMPARO FUNCHAL FAJÃ DA OVELHA	7.85		
15.14	1.38		VE 3 LOMBADA DOS MARINHEIROS FUNCHAL FAJÃ DA OVELHA	6.47		

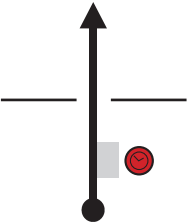

CH 2A - SANTA		DISTÂNCIA		ETAPA		Página	
CH 3A - C. F. PRAZERES/M. ABASTECEDOR (REAG.)		21.61 Km		SECÇÃO		39	
Prova Especial		3		MÉDIA		TEMPO	
Golfe Calheta 1		10.93 Km		37.0 Km/h		35 MIN	
Distância		Direção	Apênd. Prog.	Informação		Dist. to go Dist. Regr.	
Total	Parcial						
17.09	1.95	 11		VE 3 FAJÁ DA OVELHA FUNCHAL CALHETA	4.52		
18.04	0.95	 12		VE 3 TRÂNSITO LOCAL FUNCHAL RIBEIRA BRAVA CALHETA PRAZERES	3.57		
20.81	2.77	 13		VE 3 PRAZERES LOMBO DA ROCHA HOTEL	0.80		
20.89	0.08	 14		CAMINHO LOMBO DA ROCHA 	0.72		
21.31	0.42	 15		CAMINHO LOMBO DA ROCHA TRAVESSA DA FIGUEIRA	0.30		



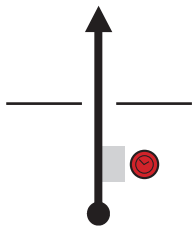

CH 2A - SANTA	DISTÂNCIA	ETAPA	1	Página
CH 3A - C. F. PRAZERES/M. ABASTECEDOR (REAG.)	21.61 Km	SECÇÃO	2	40
Prova Especial	3	MÉDIA	TEMPO	35 MIN
<i>Golfe Calheta 1</i>	10.93 Km	37.0 Km/h		

Distância		Direção	Informação	Dist. Regr.										
Total	Parcial													
21.45	0.14	 <div style="border: 1px solid black; padding: 2px; width: fit-content; margin: 5px auto;">16</div>	<p>TRAVESSA DA FIGUEIRA</p> <table border="1" style="width: 100%; border-collapse: collapse;"> <tr> <td>ESCOLA →</td> <td>JUNTA FREGUESIA →</td> </tr> <tr> <td>MERCADO ABASTECEDOR →</td> <td>CENTRO DE DIA →</td> </tr> <tr> <td>← IGREJA</td> <td>CENTRO DE SAÚDE →</td> </tr> <tr> <td>← QTA. PEDAGÓGICA</td> <td>SEGURANÇA SOCIAL →</td> </tr> <tr> <td>← CLUBE DESPORTIVO</td> <td>ZONA DESPORTIVA →</td> </tr> </table>	ESCOLA →	JUNTA FREGUESIA →	MERCADO ABASTECEDOR →	CENTRO DE DIA →	← IGREJA	CENTRO DE SAÚDE →	← QTA. PEDAGÓGICA	SEGURANÇA SOCIAL →	← CLUBE DESPORTIVO	ZONA DESPORTIVA →	0.16
ESCOLA →	JUNTA FREGUESIA →													
MERCADO ABASTECEDOR →	CENTRO DE DIA →													
← IGREJA	CENTRO DE SAÚDE →													
← QTA. PEDAGÓGICA	SEGURANÇA SOCIAL →													
← CLUBE DESPORTIVO	ZONA DESPORTIVA →													
21.54	0.09	 SEGURANÇA SOCIAL <div style="border: 1px solid black; padding: 2px; width: fit-content; margin: 5px auto;">17</div>	<p>CAMINHO DA REFERTA</p> <p>CAMINHO DA REFERTA</p> <table border="1" style="width: 100%; border-collapse: collapse;"> <tr> <td>MERCADO ABASTECEDOR ↑</td> </tr> <tr> <td>← ESCOLA</td> </tr> <tr> <td>← ZONA DESPORTIVA</td> </tr> </table>	MERCADO ABASTECEDOR ↑	← ESCOLA	← ZONA DESPORTIVA	0.07							
MERCADO ABASTECEDOR ↑														
← ESCOLA														
← ZONA DESPORTIVA														
21.61	0.07	 <div style="border: 1px solid black; padding: 2px; width: fit-content; margin: 5px auto;">18</div>	<p>C. F. PRAZERES / M. ABASTECEDOR REAGRUPAMENTO ENTRADA</p> <table border="1" style="width: 100%; border-collapse: collapse;"> <tr> <td style="text-align: center;">  3A </td> <td> N 32°45'5.31" W 17°12'17.40" </td> </tr> </table>	 3A	N 32°45'5.31" W 17°12'17.40"	0.00								
 3A	N 32°45'5.31" W 17°12'17.40"													

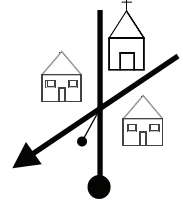
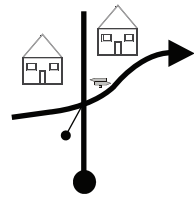
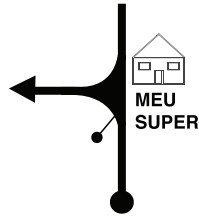
**CAMPO DE FUTEBOL DOS PRAZERES
E MERCADO ABASTECEDOR
REAGRUPAMENTO
(10 MIN)**

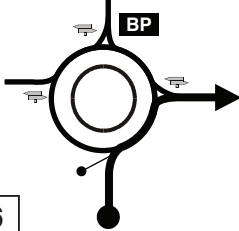
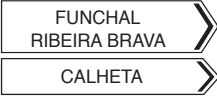
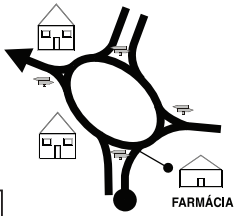
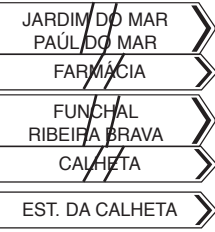
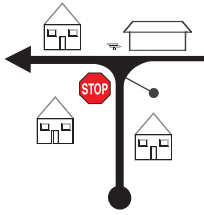
CH 3B - C. F. PRAZERES/M. ABASTECEDOR (REAG.)	DISTÂNCIA	ETAPA	1	Página
CH 3C - PRAZERES	9.88 Km	SECÇÃO	3	41
Prova Especial	MÉDIA	TEMPO	19 MIN	
	31.2 Km/h			

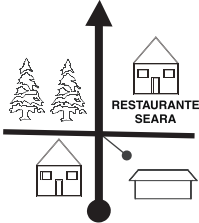
Distância		Direção	Informação	Dist. Regr.
Total	Parcial			
0.00	0.00	 <p>1</p>	<p>C. F. PRAZERES / M. ABASTECEDOR REAGRUPAMENTO SAÍDA</p>  <p>N 32°45'5.14" W 17°12'15.44"</p> <p>3B</p>	9.88
0.12	0.12	 <p>2</p>	<p>CAMINHO DA REFERTA</p>	9.76
0.44	0.32	 <p>3</p>	<p>CAMINHO DA REFERTA</p>	9.44
0.67	0.23	 <p>4</p>	<p>CAMINHO LOMBO DA ROCHA</p> <p>HOTEL APARTAMENTOS JARDIM ATLÂNTICO</p>	9.21
1.12	0.45	 <p>5</p>	<p>CAMINHO LOMBO DA ROCHA</p> <p>VE 3</p>	8.76

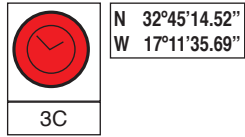
CH 3B - C. F. PRAZERES/M. ABASTECEDOR (REAG.)		DISTÂNCIA		ETAPA	1	Página
CH 3C - PRAZERES		9.88 Km		SECÇÃO	3	42
Prova Especial		MÉDIA		TEMPO		19 MIN
Distância		Direção		Informação		Dist. Regr.
Total	Parcial					
1.20	0.08			VE 3 		8.68
		6				
5.00	3.80			VE 3 		4.88
		7				
6.53	1.53			ER 223 		3.35
		8				
8.95	2.42			ER 222 ER 222		0.93
		9				
9.88	0.93			ER 222 		0.00
		10				
						(1.12)

CH 3B - C. F. PRAZERES/M. ABASTECEDOR (REAG.)	DISTÂNCIA	ETAPA	1	Página
CH 3C - PRAZERES	9.88 Km	SECÇÃO	3	43
Prova Especial	MÉDIA	TEMPO	19 MIN	
		31.2 Km/h		

Distância		Direção	Apênd. Prog.	Informação	Dist. Regr.
Total	Parcial				
	0.025			ER 222 INÍCIO DE ZONA DE AQUECIMENTO DE PNEUS	
	1.02			ER 222 FIM DE ZONA DE AQUECIMENTO DE PNEUS	
	1.12			ER 222 <div style="border: 1px solid black; padding: 2px; width: fit-content;"> N 32°45'17.26" W 17°12'4.83" </div>	

PRAZERES

Segurança na PEC



ZONA DE AQUECIMENTO DE PNEUS (ZAP) 

Nº POSTO DE TELECOMUNICAÇÕES COM DISTÂNCIA DA PARTIDA 

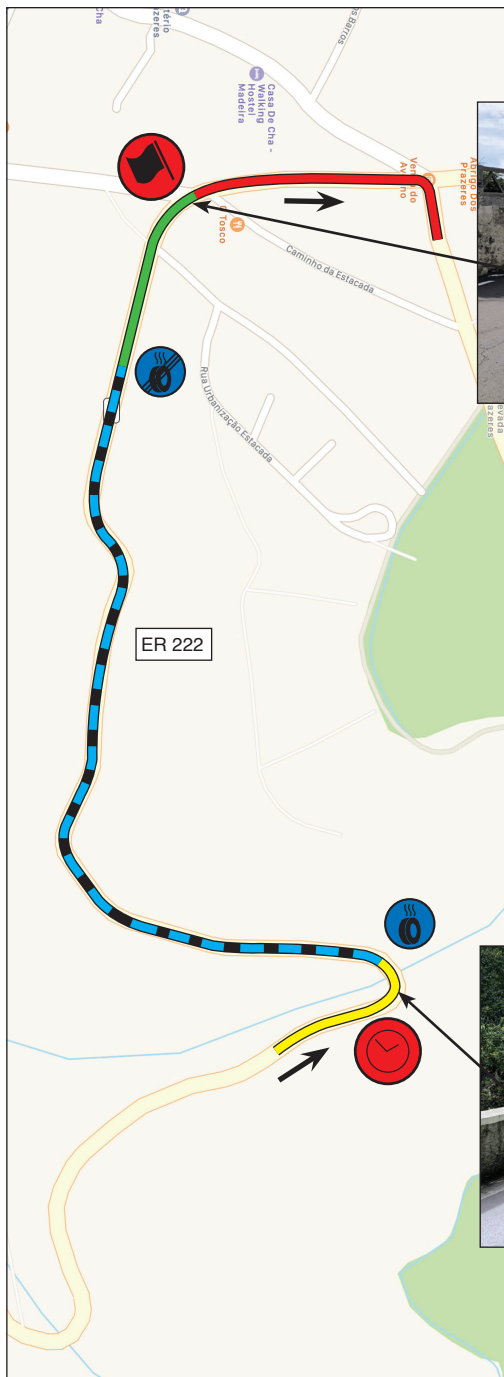

PRAZERES • PEC 4 - 11:40h



CHC ← 1120 mts → P

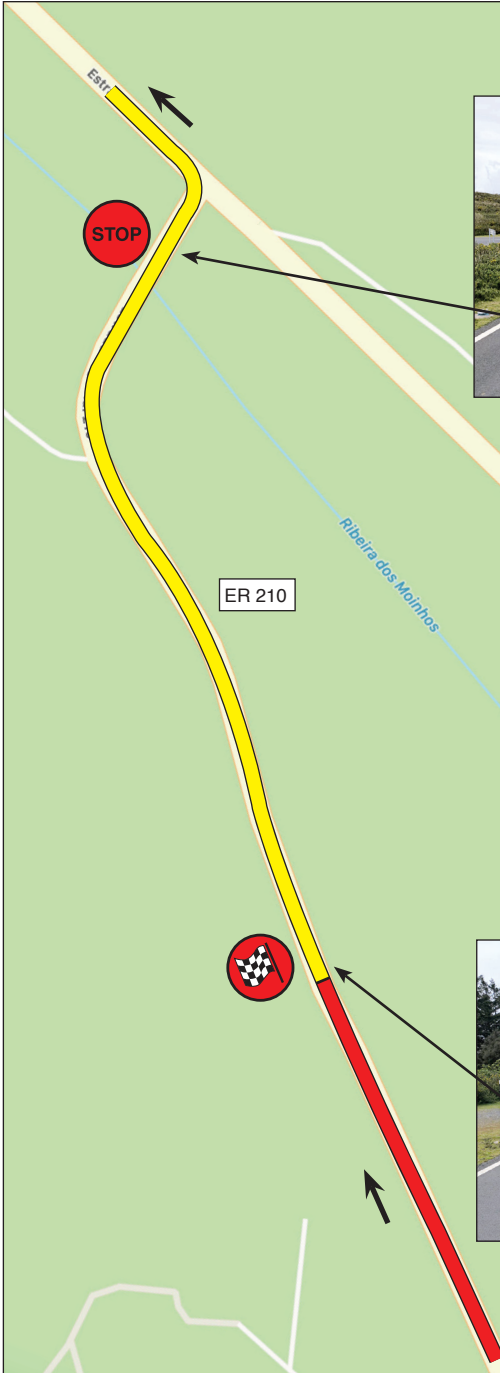

PRAZERES · PEC 4 - 11:40h







M ← 370 mts → S

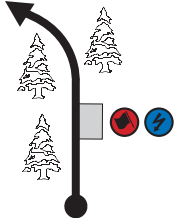

CH 3C - PRAZERES	DISTÂNCIA	ETAPA	1	Página
CH 4A - SANTA	17.29 Km	SECÇÃO	3	47
Prova Especial <i>Prazeres 2</i>	4 7.66 Km	MÉDIA	38.4 Km/h	TEMPO 27 MIN

Distância		Direção	Informação	Dist. to go Dist. Regr.
Total	Parcial			
0.00	0.00		ER 222 <div style="border: 1px solid black; padding: 2px;"> N 32°45'17.26" W 17°12'4.83" </div> 	17.29
0.15	0.15		ER 222 <div style="border: 1px solid black; padding: 2px;"> FONTE DO BISPO → RABAÇAL → PAÚL DA SERRA → LEVADA → </div>	17.14
4.12	3.97		ER 210 ER 210 <div style="border: 1px solid black; padding: 2px;"> N 32°46'37.64" W 17°11'20.44" </div>	13.17
6.70	2.58		ER 210 <div style="border: 1px solid black; padding: 2px;"> < FONTE DO BISPO PAÚL DA SERRA > </div>	10.59
7.66	0.96		ER 210 <div style="border: 1px solid black; padding: 2px;"> N 32°47'37.30" W 17°10'54.73" </div>	9.63

CH 3C - PRAZERES		DISTÂNCIA		ETAPA		Página	
CH 4A - SANTA		17.29 Km		SECÇÃO		48	
Prova Especial		4		MÉDIA		TEMPO	
Prazeres 2		7.66 Km		38.4 Km/h		27 MIN	
Distância		Direção	Asfalto / Paved	Informação		Dist. to go Dist. Reqr.	
Total	Parcial						
8.03	0.37		Asfalto / Paved			9.26	
17.16	9.13					0.13	
17.29	0.13					0.00	
					(0.98)		
	0.025						
	0.88						

CH 3C - PRAZERES		DISTÂNCIA		ETAPA	1	Página	49
CH 4A - SANTA		17.29 Km		SECÇÃO	3		
Prova Especial		4	MÉDIA	TEMPO		27 MIN	
Prazeres 2		7.66 Km	38.4 Km/h				
Distância		Direção	Apênd. Prog.	Informação		Dist. Regr.	
Total	Parcial						
	0.98			ER 101		<div style="border: 1px solid black; padding: 2px;"> N 32°50'24.81" W 17°11'39.77" </div> <div style="display: flex; justify-content: space-around; align-items: center;"> <div style="text-align: center;">  T-1 </div> <div style="text-align: center;">  5 </div> <div style="text-align: center;">  </div> </div>	
	11						







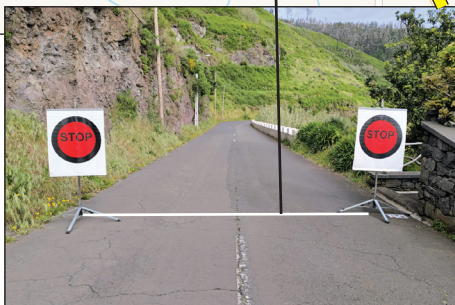
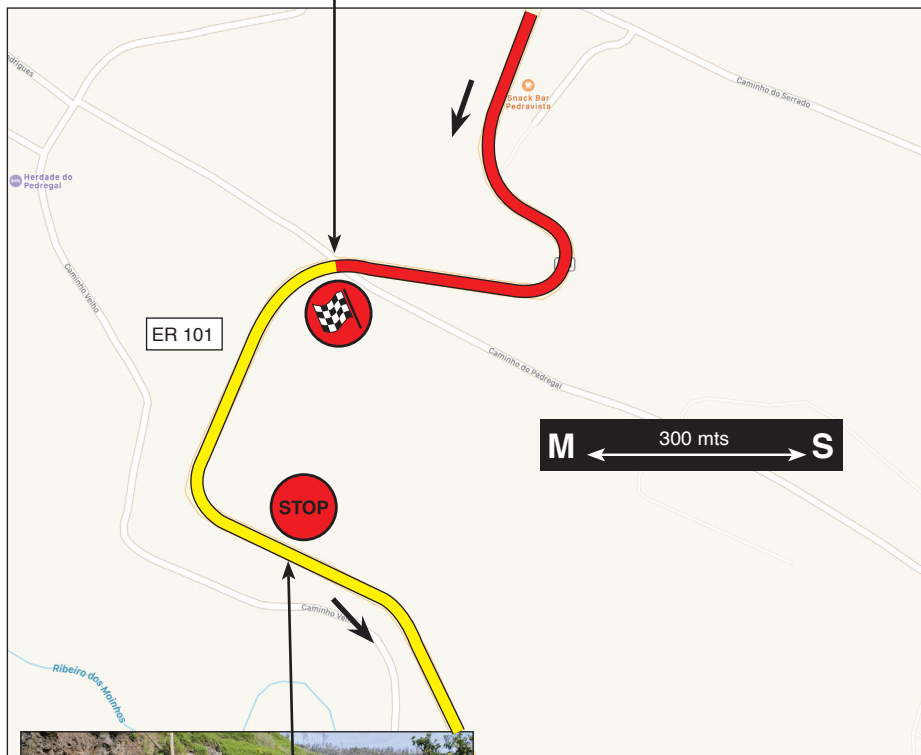



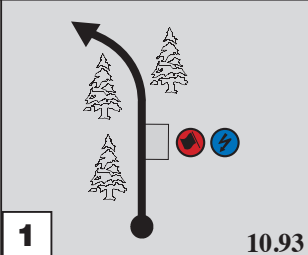

GOLFE CALHETA • PEC 5 - 12:10h

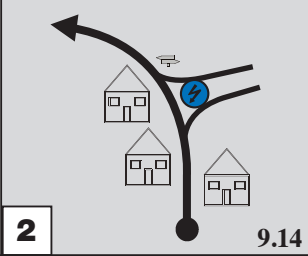

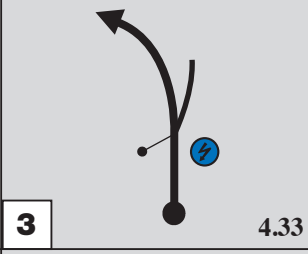

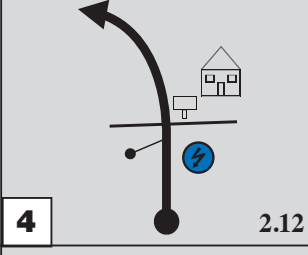

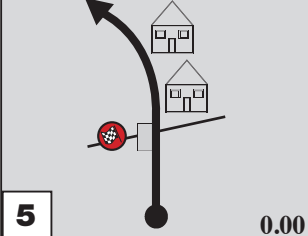



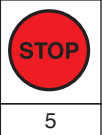

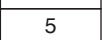



GOLFE CALHETA • PEC 5 - 12:10h





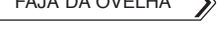

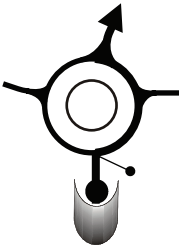
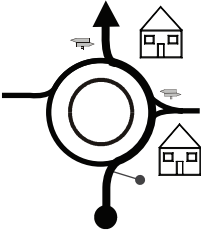
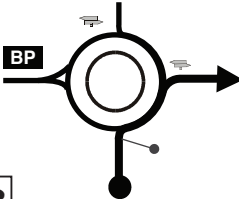
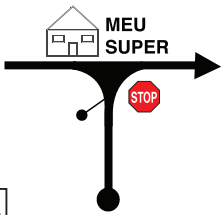

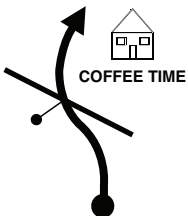

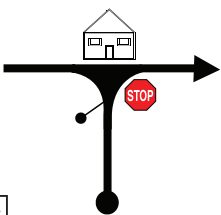

CH 4A - SANTA	DISTÂNCIA	ETAPA	1	Página
CH 5A - C. F. PRAZERES/M. ABASTECEDOR - (REAG.)	21.61 Km	SECÇÃO	3	53
Prova Especial <i>Golfe Calheta 2</i>	5 10.93 Km	MÉDIA	37.0 Km/h	TEMPO 35 MIN

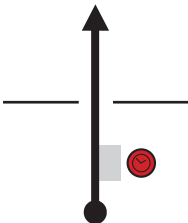
Distância		Direção	Informação	Dist. to go Dist. Regr.
Total	Parcial			
0.00	0.00	 <p>1 10.93</p>	ER 101   <p>5</p> <p>N 32°50'24.81" W 17°11'39.77"</p>  	21.61
1.79	1.79	 <p>2 9.14</p>	ER 223   <p>T-2</p> <p>FUNCHAL PONTA DO PARGO</p> <p>N 32°50'24.84" W 17°12'31.85"</p>	19.82
6.60	4.81	 <p>3 4.33</p>	ER 101  <p>T-3</p> <p>N 32°49'43.29" W 17°13'29.84"</p> 	15.01
8.81	2.21	 <p>4 2.12</p>	ER 101  <p>T-4</p> <p>RIBEIRA DA VACA</p> <p>N 32°49'18.39" W 17°13'55.38"</p>	12.80
10.93	2.12	 <p>5 0.00</p>	ER 101  <p>5</p> <p>N 32°49'3.09" W 17°14'32.54"</p>	10.68

CH 5 - SANTA		DISTÂNCIA		ETAPA	1	Página
CH 5A - C. F. PRAZERES/M. ABASTECEDOR - (REAG.)		21.61 Km		SECÇÃO	3	54
Prova Especial		5		MÉDIA	TEMPO	
Golfe Calheta 2		10.93 Km		37.0 Km/h		35 MIN
Distância		Direção	Alpha	Beta	Informação	Dist. to go Dist. Repr.
Total	Parcial					
11.23	0.30				ER 101  N 32°48'56.56" W 17°14'34.04"  T-5 	10.38
12.18	0.95				ER 101    VE 3 VE 3	9.43
12.96	0.78				VE 3  	8.65
13.76	0.80				VE 3   	7.85
15.14	1.38				VE 3   	6.47

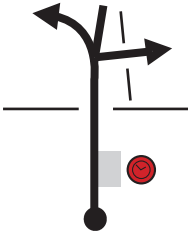
CH 5 - SANTA		DISTÂNCIA		ETAPA		Página	
CH 5A - C. F. PRAZERES/M. ABASTECEDOR - (REAG.)		21.61 Km		SECÇÃO		55	
Prova Especial		5		MÉDIA		TEMPO	
Golfe Calheta 2		10.93 Km		37.0 Km/h		35 MIN	
Distância		Direção	Apênd. Prog.	Informação		Dist. to go Dist. Regr.	
Total	Parcial						
17.09	1.95	 11		VE 3 FAJÃ DA OVELHA FUNCHAL CALHETA		4.52	
18.04	0.95	 12		VE 3 TRÂNSITO LOCAL FUNCHAL RIBEIRA BRAVA CALHETA PRAZERES		3.57	
20.81	2.77	 13		VE 3 PRAZERES LOMBO DA ROCHA HOTEL		0.80	
20.89	0.08	 14		CAMINHO LOMBO DA ROCHA 		0.72	
21.31	0.42	 15		CAMINHO LOMBO DA ROCHA TRAVESSA DA FIGUEIRA		0.30	

CH 5 - SANTA	DISTÂNCIA	ETAPA	1	Página
CH 5A - C. F. PRAZERES/M. ABASTECEDOR - (REAG.)	21.61 Km	SECÇÃO	3	56
Prova Especial <i>Golfe Calheta 2</i>	5 10.93 Km	MÉDIA	37.0 Km/h	TEMPO 35 MIN

Distância		Direção	Informação	Dist. Regr.										
Total	Parcial													
21.45	0.14	 16	TRAVESSA DA FIGUEIRA <table border="1" data-bbox="543 311 901 438"> <tr> <td>ESCOLA →</td> <td>JUNTA FREGUESIA →</td> </tr> <tr> <td>MERCADO ABASTECEDOR →</td> <td>CENTRO DE DIA →</td> </tr> <tr> <td>← IGREJA</td> <td>CENTRO DE SAÚDE →</td> </tr> <tr> <td>← QTA. PEDAGÓGICA</td> <td>SEGURANÇA SOCIAL →</td> </tr> <tr> <td>← CLUBE DESPORTIVO</td> <td>ZONA DESPORTIVA →</td> </tr> </table>	ESCOLA →	JUNTA FREGUESIA →	MERCADO ABASTECEDOR →	CENTRO DE DIA →	← IGREJA	CENTRO DE SAÚDE →	← QTA. PEDAGÓGICA	SEGURANÇA SOCIAL →	← CLUBE DESPORTIVO	ZONA DESPORTIVA →	0.16
ESCOLA →	JUNTA FREGUESIA →													
MERCADO ABASTECEDOR →	CENTRO DE DIA →													
← IGREJA	CENTRO DE SAÚDE →													
← QTA. PEDAGÓGICA	SEGURANÇA SOCIAL →													
← CLUBE DESPORTIVO	ZONA DESPORTIVA →													
21.54	0.09	 17	CAMINHO DA REFERTA CAMINHO DA REFERTA <table border="1" data-bbox="610 566 828 662"> <tr> <td>MERCADO ABASTECEDOR ↑</td> </tr> <tr> <td>← ESCOLA</td> </tr> <tr> <td>← ZONA DESPORTIVA</td> </tr> </table>	MERCADO ABASTECEDOR ↑	← ESCOLA	← ZONA DESPORTIVA	0.07							
MERCADO ABASTECEDOR ↑														
← ESCOLA														
← ZONA DESPORTIVA														
21.61	0.07	 18	C. F. PRAZERES / M. ABASTECEDOR REAGRUPAMENTO (75 MINUTOS) ENTRADA <table border="1" data-bbox="599 869 840 1005"> <tr> <td></td> <td>N 32°45'5.31"</td> </tr> <tr> <td></td> <td>W 17°12'17.40"</td> </tr> <tr> <td>5A</td> <td></td> </tr> </table>		N 32°45'5.31"		W 17°12'17.40"	5A		0.00				
	N 32°45'5.31"													
	W 17°12'17.40"													
5A														
	0.10	 19	C. F. PRAZERES / M. ABASTECEDOR PARQUE DE ASSISTÊNCIAS ENTRADA <table border="1" data-bbox="599 1125 840 1260"> <tr> <td></td> <td>N 32°45'5.14"</td> </tr> <tr> <td></td> <td>W 17°12'15.44"</td> </tr> <tr> <td>5B</td> <td></td> </tr> </table>		N 32°45'5.14"		W 17°12'15.44"	5B						
	N 32°45'5.14"													
	W 17°12'15.44"													
5B														







**CAMPO DE FUTEBOL DOS PRAZERES
E MERCADO ABASTECEDOR
PARQUE DE ASSISTÊNCIAS C
(30 MIN)**



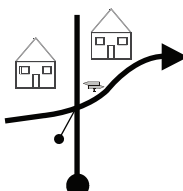

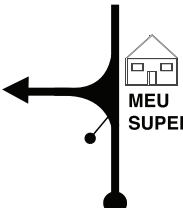
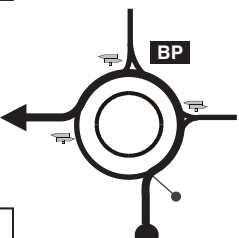

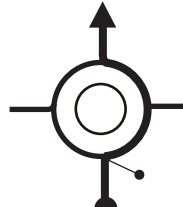
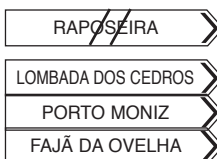
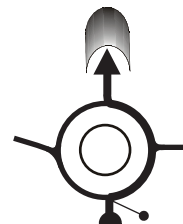
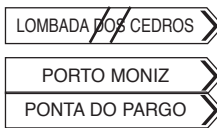

CH 5C - C. F. PRAZERES/M. ABASTECEDOR - PA (C)	DISTÂNCIA	ETAPA	1	Página
CH 5D - PONTA DO PARGO	10.06 Km	SECÇÃO	4	57
Prova Especial	MÉDIA	TEMPO	22 MIN	
		27.4 Km/h		

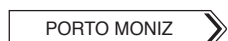
Distância		Direção	Informação	Dist. to go Dist. Regr.
Total	Parcial			
0.00	0.00	<p>1</p>	<p>C. F. PRAZERES / M. ABASTECEDOR PARQUE DE ASSISTÊNCIAS SAÍDA</p> <p>N 32°45'1.00" W 17°12'18.32"</p> <p>5C PA - C</p>	10.06
0.03	0.03	<p>2</p>	<p>MERCADO ABASTECEDOR REABASTECIMENTO (INÍCIO)</p> <p>N 32°45'1.40" W 17°12'19.43"</p>	10.03
0.06	0.03	<p>3</p>	<p>MERCADO ABASTECEDOR REABASTECIMENTO (SAÍDA)</p> <p>N 32°45'1.72" W 17°12'20.44"</p>	10.00
0.07	0.01	<p>4</p>	<p>MERCADO ABASTECEDOR SAÍDA</p> <p>CAMINHO DA REFERTA</p>	9.99
0.52	0.45	<p>5</p>	<p>CAMINHO DA REFERTA</p> <p>CAMINHO LOMBO DA ROCHA</p>	9.54

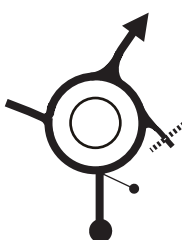
CH 5C - C. F. PRAZERES/M. ABASTECEDOR - PA (C)	DISTÂNCIA	ETAPA	1	Página
CH 5D - PONTA DO PARGO		10.06 Km	SECÇÃO	4
Prova Especial	MÉDIA	27.4 Km/h	TEMPO	22 MIN

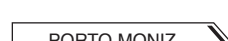
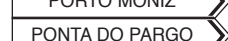
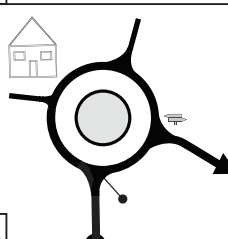
Distância		Direção	Informação	Dist. to go Dist. Repr.
Total	Parcial			
0.75	0.23		CAMINHO LOMBO DA ROCHA 	9.31
		6		
1.20	0.45		CAMINHO LOMBO DA ROCHA VE 3	8.86
		7		
1.28	0.08		VE 3 	8.78
		8		
4.08	2.80		VE 3 	5.98
		9		
5.05	0.97		VE 3 	5.01
		10		

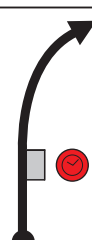
CH 5C - C. F. PRAZERES/M. ABASTECEDOR - PA (C)	DISTÂNCIA	ETAPA	1	Página
CH 5D - PONTA DO PARGO	10.06 Km	SECÇÃO	4	59
Prova Especial	MÉDIA	TEMPO	22 MIN	
	27.4 Km/h			

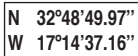
Distância		Direção	Apêndice Prog.	Informação	Dist. Regr.
Total	Parcial				
6.99	1.94			VE 3  	3.07
		11			
8.86	1.37			VE 3 	1.70
		12			
9.16	0.80			VE 3  	0.90
		13			
9.92	0.76			VE 3  	0.14
		14			
10.06	0.14			ER 101 ER 101   W 17°14'37.16\" data-bbox="690 885 810 910"/> 5D	0.00
		15			

(1.13)

CH 5C - C. F. PRAZERES/M. ABASTECEDOR - PA (C)	DISTÂNCIA	ETAPA	1	Página
CH 5D - PONTA DO PARGO		10.06 Km	SECÇÃO	4
Prova Especial	MÉDIA	27.4 Km/h	TEMPO	22 MIN

Distância		Direção	Informação	Dist. Regr.
Total	Parcial			
	0.025		ER 101 INÍCIO DE ZONA DE AQUECIMENTO DE PNEUS	
	16			
	1.03		ER 101 FIM DE ZONA DE AQUECIMENTO DE PNEUS	
	17			
	1.13		ER 101 N 32°49'2.92" W 17°14'32.77" T-1 6 	
	18			

NOTAS

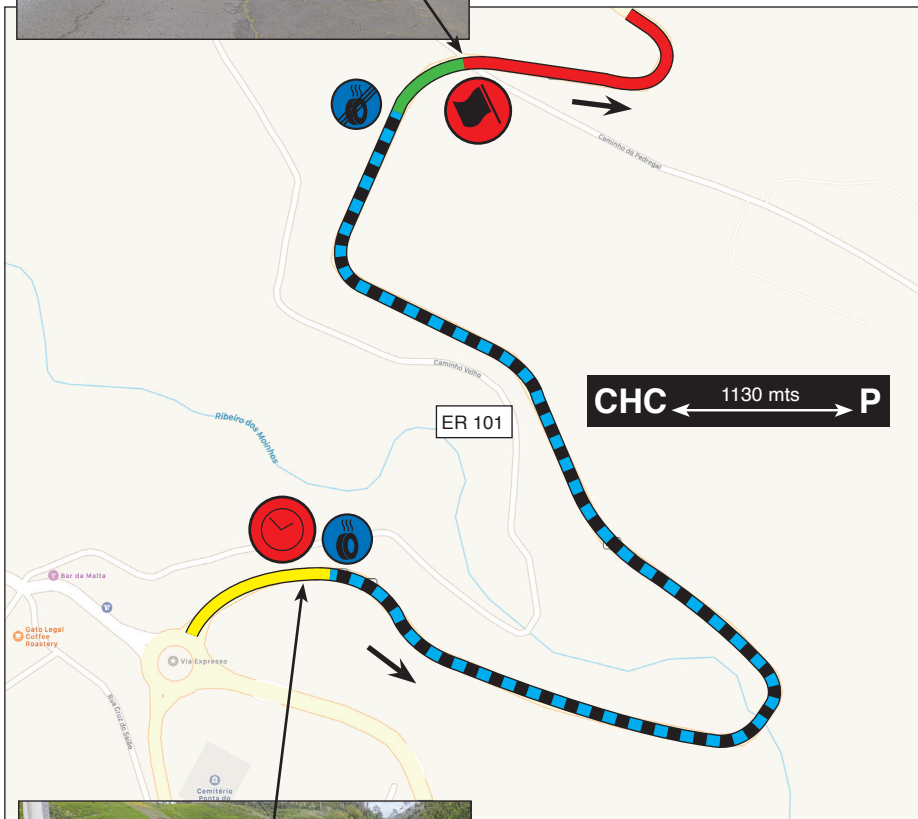









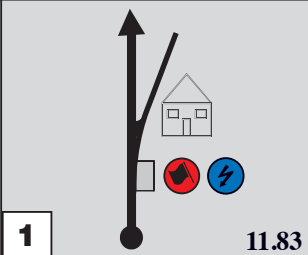

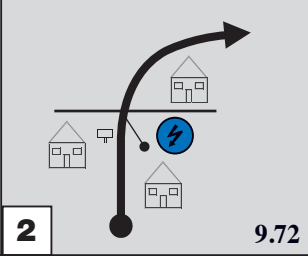

PONTA DO PARGO • PEC 6 - 14:55h

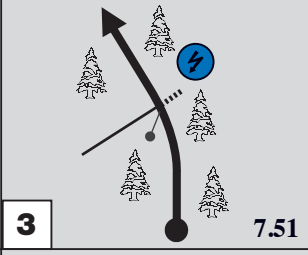

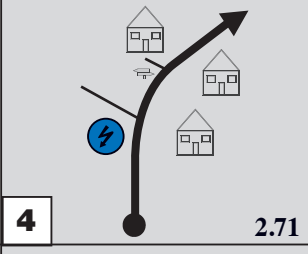

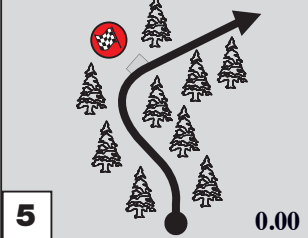

M ← 180 mts → S

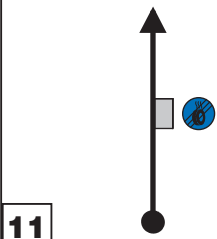

CH 5D - PONTA DO PARGO		DISTÂNCIA		ETAPA		Página		
CH 6A - FONTE DO BISPO		25.67 Km		SECCÃO		65		
Prova Especial		6		MÉDIA		TEMPO		
Ponta do Pargo 1		11.83 Kms		41.6 Km/h		37 MIN		
Distância		Direção		Informação		Dist. Regr.		
Total	Parcial							
0.00	0.00	1		ER 101 N 32°49'2.92" W 17°14'32.77"	 T-1	 6	 	25.67
2.11	2.11	2		ER 101 RIBEIRA DA VACA N 32°49'18.39" W 17°13'55.38"	 T-2			23.56
4.32	2.21	3		ER 101 N 32°49'43.29" W 17°13'29.84"	 T-3			21.35
9.12	4.80	4		ER 101 TELEFERICO N 32°50'24.84" W 17°12'31.85"	 T-4			16.55
11.83	2.71	5		ER 101 N 32°50'38.69" W 17°11'38.17"	 6			13.84

CH 6 - PONTA DO PARGO		DISTÂNCIA		ETAPA	1	Página
CH 6A - FONTE DO BISPO		25.67 Km		SECÇÃO	4	66
Prova Especial		6		MÉDIA	TEMPO	
Ponta do Pargo 1		11.83 Kms		41.6 Km/h		37 MIN
Distância		Direção	Asfalto / Parg	Informação		Dist. Regr.
Total	Parcial					
12.01	0.18			ER 101 	 N 32°50'43.26" W 17°11'40.74" 	13.66
	6			ER 105		
21.10	9.09				ER 105	4.57
	7			ER 210		
22.38	1.28				ER 210	3.29
	8			ER 210		
25.67	3.29			N 32°46'24.13" W 17°11'30.73" 	ER 210	0.00
	9			(0.80)		
	0.025				ER 210	
	10					

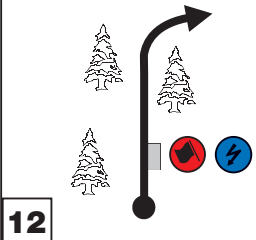
CH 6 - PONTA DO PARGO	DISTÂNCIA	ETAPA	1	Página
CH 6A - FONTE DO BISPO	25.67 Km	SECÇÃO	4	67
Prova Especial	6	MÉDIA		
<i>Ponta do Pargo 1</i>	11.83 Kms	41.6 Km/h	TEMPO	37 MIN

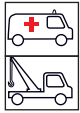
Distância		Direção	Apênd. Prog.	Informação	Dist. Regr.
Total	Parcial				
	0.70			ER 210  <p>FIM DE ZONA DE AQUECIMENTO DE PNEUS</p>	
	11				
	0.80			ER 210 N 32°46'14.60" W 17°11'20.49"  T-1  7 	
	12				

FONTE DO BISPO RAPOSEIRA Segurança na PEC

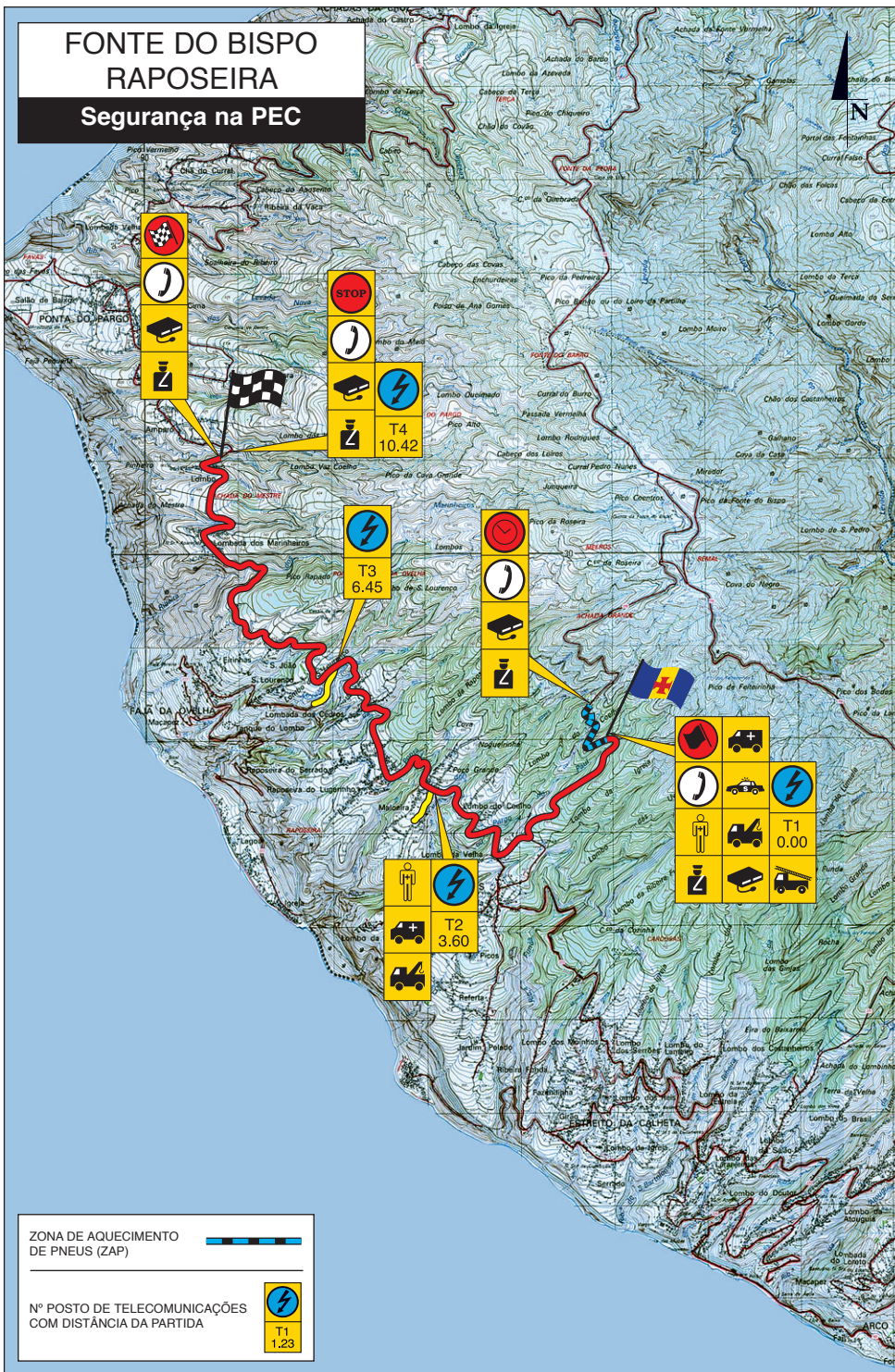

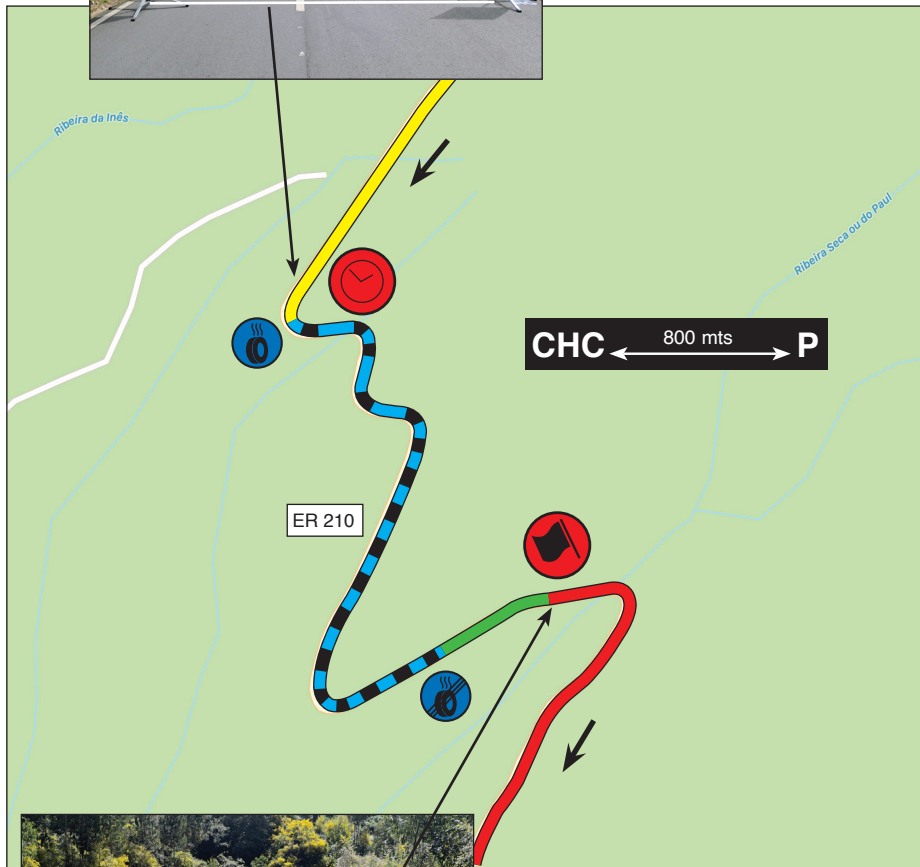

FORTE DO BISPO-RAPOSEIRA • PEC 7 - 15:35h





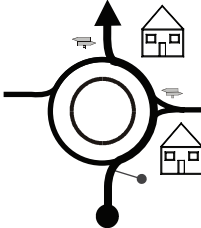
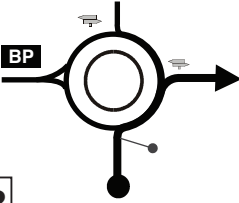
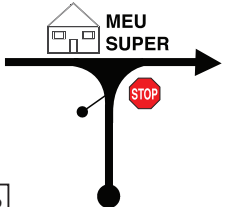

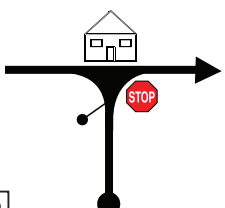
CH 6A - FONTE DO BISPO		DISTÂNCIA		ETAPA		Página	
CH 7A - C. F. PRAZERES/M. ABASTECEDOR (REAG.)		17.24 Km		SECÇÃO		4	
Prova Especial		7		MÉDIA		TEMPO	
Fonte do Bispo-Raposeira 1		10.18 Kms		41.4 Km/h		25 MIN	
Distância		Direção		Informação		Dist. Regr.	
Total	Parcial						
0.00	0.00	<p>1 10.18</p>		<p>ER 210</p> <p>N 32°46'14.60" W 17°11'20.49"</p> <p>T-1 7</p>		17.24	
1.58	1.58	<p>2 8.60</p>		<p>ER 210</p> <p>CAMINHO LOMBO DA VELHA</p>		15.66	
2.04	0.46	<p>3 8.14</p>		<p>CAMINHO LOMBO DA VELHA</p> <p>LEVADA ↔</p> <p>ER 222</p>		15.20	
3.60	1.56	<p>4 6.58</p>		<p>ER 222</p> <p>FUNCHAL PORTO MONIZ</p> <p>SAÍDA DE EMERGÊNCIA</p> <p>N 32°45'55.66" W 17°12'30.53"</p> <p>T-2</p>		13.64	
6.45	2.85	<p>5 3.73</p>		<p>ER 222</p> <p>FAJÁ DA OVELHA</p> <p>FUNCHAL</p> <p>SAÍDA DE EMERGÊNCIA</p> <p>N 32°46'39.72" W 17°13'7.01"</p> <p>T-3</p>		10.79	

CH 6A - FONTE DO BISPO		DISTÂNCIA		ETAPA	1	Página	
CH 7A - C. F. PRAZERES/M. ABASTECEDOR (REAG.)		17.24 Km		SECÇÃO	4	72	
Prova Especial		7		MÉDIA	TEMPO		
Fonte do Bispo-Raposeira 1		10.18 Kms		41.4 Km/h		25 MIN	
Distância		Direção	Alpha	Pitag	Informação		Dist. Repr.
Total	Parcial						
10.18	3.73	<div style="border: 1px solid black; padding: 5px;"> </div>			ER 222 N 32°47'18.84" W 17°14'5.12" 7	7.06	
10.42	0.24	<div style="border: 1px solid black; padding: 5px;"> </div>			ER 222 N 32°47'25.11" W 17°14'7.80" 7 T-4	6.82	
10.73	0.31	<div style="border: 1px solid black; padding: 5px;"> </div>			ER 222 VE 3	6.51	
10.80	0.07	<div style="border: 1px solid black; padding: 5px;"> </div>			VE 3 	6.44	
12.72	1.92	<div style="border: 1px solid black; padding: 5px;"> </div>			VE 3 	4.52	

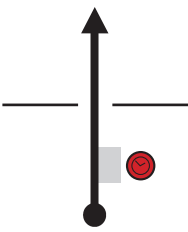



CH 6A - FONTE DO BISPO		DISTÂNCIA		ETAPA		1		Página											
CH 7A - C. F. PRAZERES/M. ABASTECEDOR (REAG.)		17.24 Km		SECÇÃO		4		73											
Prova Especial		7		MÉDIA		TEMPO		25 MIN											
Fonte do Bispo-Raposeira 1		10.18 Kms		41.4 Km/h															
Distância		Direção		Informação		Dist. Regr.													
Total	Parcial																		
13.67	0.95	11		VE 3 TRÂNSITO LOCAL FUNCHAL RIBEIRA BRAVA CALHETA PRAZERES		3.57													
16.43	2.76	12		VE 3 PRAZERES LOMBO DA ROCHA HOTEL CAMINHO LOMBO DA ROCHA		0.81													
16.52	0.09	13		CAMINHO LOMBO DA ROCHA		0.72													
16.94	0.42	14		CAMINHO LOMBO DA ROCHA TRAVESSA DA FIGUEIRA		0.30													
17.08	0.14	15		TRAVESSA DA FIGUEIRA <table border="1"> <tr> <td>ESCOLA →</td> <td>JUNTA FREGUESIA →</td> </tr> <tr> <td>MERCADO ABASTECEDOR →</td> <td>CENTRO DE DIA →</td> </tr> <tr> <td>← IGREJA</td> <td>CENTRO DE SAÚDE →</td> </tr> <tr> <td>← QTA. PEDAGÓGICA</td> <td>SEGURANÇA SOCIAL →</td> </tr> <tr> <td>← CLUBE DESPORTIVO</td> <td>ZONA DESPORTIVA →</td> </tr> </table> CAMINHO DA REFERTA		ESCOLA →	JUNTA FREGUESIA →	MERCADO ABASTECEDOR →	CENTRO DE DIA →	← IGREJA	CENTRO DE SAÚDE →	← QTA. PEDAGÓGICA	SEGURANÇA SOCIAL →	← CLUBE DESPORTIVO	ZONA DESPORTIVA →	0.16			
ESCOLA →	JUNTA FREGUESIA →																		
MERCADO ABASTECEDOR →	CENTRO DE DIA →																		
← IGREJA	CENTRO DE SAÚDE →																		
← QTA. PEDAGÓGICA	SEGURANÇA SOCIAL →																		
← CLUBE DESPORTIVO	ZONA DESPORTIVA →																		

CH 6A - FONTE DO BISPO	DISTÂNCIA	ETAPA	1	Página
CH 7A - C. F. PRAZERES/M. ABASTECEDOR (REAG.)	17.24 Km	SECÇÃO	4	74
Prova Especial	7	MÉDIA	41.4 Km/h	TEMPO
Fonte do Bispo-Raposeira 1	10.18 Kms			25 MIN

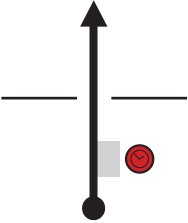

Distância		Direção	Informação	Dist. Regr.						
Total	Parcial									
17.17	0.09	 <p>16</p>	<p>CAMINHO DA REFERTA</p> <table border="1"> <tr> <td>MERCADO ABASTECEDOR</td> <td>↑</td> </tr> <tr> <td>←</td> <td>ESCOLA</td> </tr> <tr> <td>←</td> <td>ZONA DESPORTIVA</td> </tr> </table> <p>IMPASSE DO CAMPO</p>	MERCADO ABASTECEDOR	↑	←	ESCOLA	←	ZONA DESPORTIVA	0.07
MERCADO ABASTECEDOR	↑									
←	ESCOLA									
←	ZONA DESPORTIVA									
17.24	0.07	 <p>17</p>	<p>C. F. PRAZERES / M. ABASTECEDOR REAGRUPAMENTO ENTRADA</p> <table border="1"> <tr> <td rowspan="2"></td> <td>N 32°45'5.31"</td> </tr> <tr> <td>W 17°12'17.40"</td> </tr> <tr> <td colspan="2">7A</td> </tr> </table>		N 32°45'5.31"	W 17°12'17.40"	7A		0.00	
	N 32°45'5.31"									
	W 17°12'17.40"									
7A										

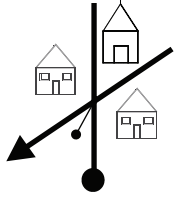
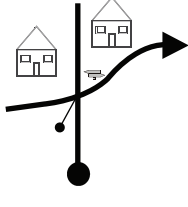
**CAMPO DE FUTEBOL DOS PRAZERES
 E MERCADO ABASTECEDOR
 REAGRUPAMENTO
 (15 MIN)**

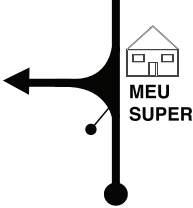



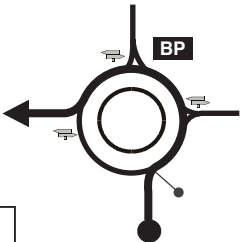
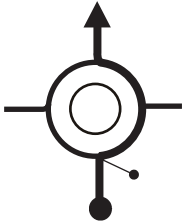
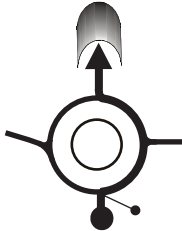

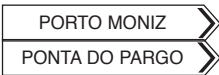

CH 7B - C. F. PRAZERES/M. ABASTECEDOR (REAG.)	DISTÂNCIA	ETAPA	1	Página
CH 7C - PONTA DO PARGO	9.98 Km	SECÇÃO	5	75
Prova Especial	MÉDIA	TEMPO	17 MIN	
		35.2 Km/h		

Distância		Direção	Informação	Dist. Regr.
Total	Parcial			
0.00	0.00	 <p>1</p>	<p>C. F. PRAZERES / M. ABASTECEDOR REAGRUPAMENTO SAÍDA</p>  <p>N 32°45'5.14" W 17°12'15.44"</p>	9.98
0.12	0.12	 <p>2</p>	CAMINHO DA REFERTA	9.86
0.44	0.32	 <p>3</p>	CAMINHO DA REFERTA	9.54
0.67	0.23	 <p>4</p>	<p>CAMINHO LOMBO DA ROCHA</p>  <p>HOTEL APARTAMENTOS JARDIM ATLÂNTICO</p>	9.31
1.12	0.45	 <p>5</p>	<p>CAMINHO LOMBO DA ROCHA</p> <p>VE 3</p>	8.86

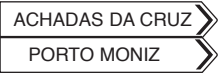
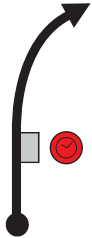
CH 7B - C. F. PRAZERES/M. ABASTECEDOR (REAG.)	DISTÂNCIA 9.98 Km	ETAPA	1	Página	76
CH 7C - PONTA DO PARGO		SECÇÃO	5		
Prova Especial	MÉDIA	35.2 Km/h	TEMPO	17 MIN	

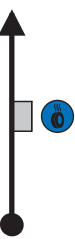
Distância		Direção	Informação	Dist. Regr.
Total	Parcial			
1.20	0.08	 <p>6</p>	<p>VE 3</p> <p>FUNCHAL RIBEIRA BRAVA</p> <p>CALHETA</p> <p>ÁREA DE SERVIÇO</p> <p>PORTO MONIZ</p> <p>PONTA DO PARGO</p> <p>PRAZERES</p>	8.78
4.00	2.80	 <p>7</p>	<p>VE 3</p> <p>RAPOSEIRA</p> <p>LOMBADA DOS CEDROS</p> <p>PORTO MONIZ</p> <p>FAJÃ DA OVELHA</p>	5.98
4.97	0.97	 <p>8</p>	<p>VE 3</p> <p>LOMBADA DOS CEDROS</p> <p>PORTO MONIZ</p> <p>PONTA DO PARGO</p>	5.01
6.91	1.94	 <p>9</p>	<p>VE 3</p> <p>PORTO MONIZ</p> <p>PONTA DO PARGO</p>	3.07
8.28	1.37	 <p>10</p>	<p>VE 3</p> <p>PONTA DO PARGO</p>	1.70

CH 7B - C. F. PRAZERES/M. ABASTECEDOR (REAG.)	DISTÂNCIA	ETAPA	1	Página
CH 7C - PONTA DO PARGO	9.98 Km	SECÇÃO	5	77
Prova Especial	MÉDIA	TEMPO	17 MIN	
		35.2 Km/h		

Distância		Direção	Informação	Dist. Regr.
Total	Parcial			
9.08	0.80	 11	VE 3 	0.90
9.84	0.76	 12	VE 3 	0.14
9.98	0.14	 13	ER 101 ER 101  7C N 32°48'49.97" W 17°14'37.16" (1.13)	0.00
	0.025	 14	ER 101  INÍCIO DE ZONA DE AQUECIMENTO DE PNEUS	0.00
	1.03	 15	ER 101  FIM DE ZONA DE AQUECIMENTO DE PNEUS	0.00

CH 7B - C. F. PRAZERES/M. ABASTECEDOR (REAG.)	DISTÂNCIA 9.98 Km	ETAPA	1	Página	78
CH 7C - PONTA DO PARGO		SECÇÃO	5		
Prova Especial	MÉDIA	35.2 Km/h		TEMPO	17 MIN

Distância		Direção	Alpha	Pwng	Informação	Dist. Regr.
Total	Parcial					
	1.13				ER 101 N 32°49'2.92" W 17°14'32.77" T-1 8 	0.00
	16					

NOTAS

PONTA DO PARGO • PEC 8 - 16:35h

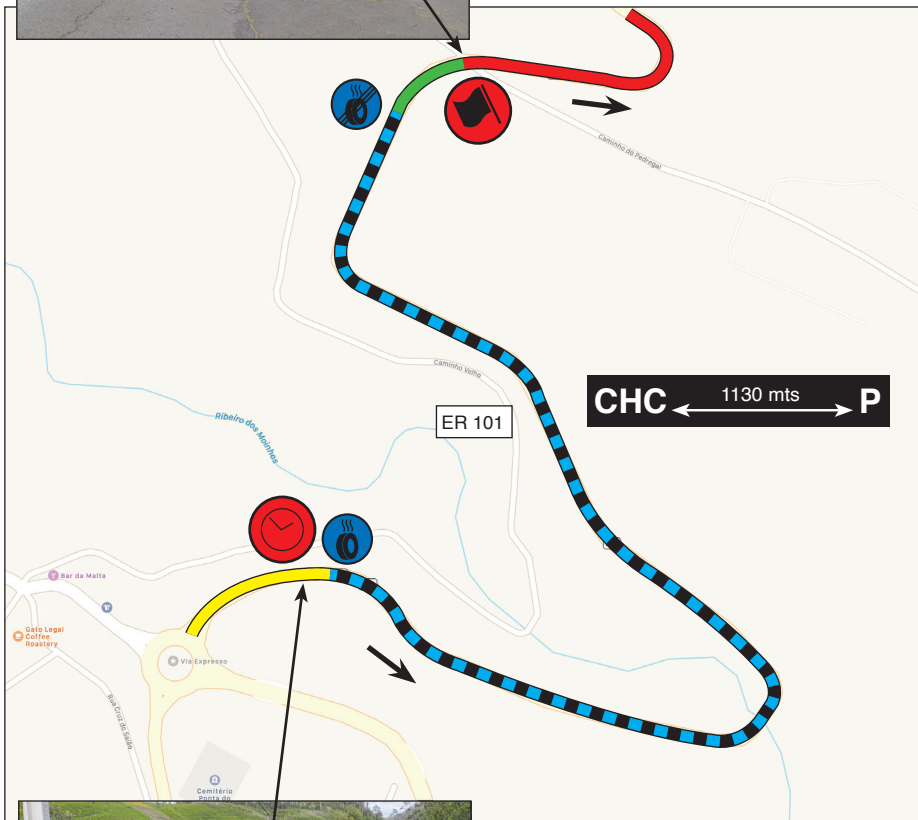









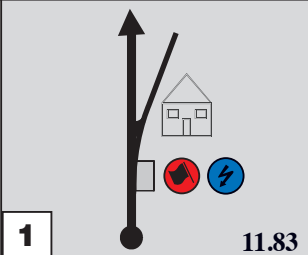

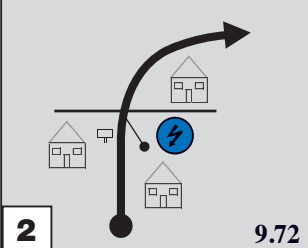

PONTA DO PARGO • PEC 8 - 16:35h

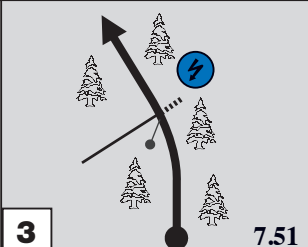

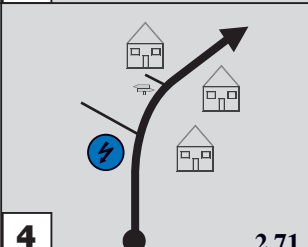
M ← 180 mts → S

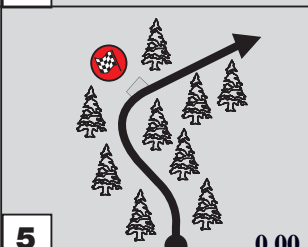

CH 7C - PONTA DO PARGO		DISTÂNCIA		ETAPA		1		Página	
CH 8A - FONTE DO BISPO		25.67 Km		SEÇÃO		5		83	
Prova Especial		8		MÉDIA		TEMPO		37 MIN	
Ponta do Pargo 2		11.83 Kms		41.6 Km/h					
Distância		Direção		Informação		Dist. Regr.			
Total	Parcial								
0.00	0.00	1			ER 101 N 32°49'2.92" W 17°14'32.77"		 	25.67	
2.11	2.11	2			ER 101 RIBEIRA DA VACA N 32°49'18.39" W 17°13'55.38"			23.56	
4.32	2.21	3			ER 101 N 32°49'43.29" W 17°13'29.84"			21.35	
9.12	4.80	4			ER 101 TELEFÉRICO N 32°50'24.84" W 17°12'31.85"			16.55	
11.83	2.71	5			ER 101 N 32°50'38.69" W 17°11'38.17"			13.84	

CH 7C - PONTA DO PARGO		DISTÂNCIA		ETAPA		1		Página	
CH 8A - FONTE DO BISPO		25.67 Km		SECÇÃO		5		84	
Prova Especial		8		MÉDIA		TEMPO		37 MIN	
Ponta do Pargo 2		11.83 Kms		41.6 Km/h					
Distância		Direção		Informação		Dist. Regr.			
Total	Parcial								
12.01	0.18							13.66	
21.10	9.09							4.57	
22.38	1.28							3.29	
25.67	3.29							0.00	
	0.025							(0.80)	

CH 7C - PONTA DO PARGO	DISTÂNCIA	ETAPA	1	Página
CH 8A - FONTE DO BISPO	25.67 Km	SECÇÃO	5	85
Prova Especial	8	MÉDIA	TEMPO	
<i>Ponta do Pargo 2</i>	11.83 Kms	41.6 Km/h	37 MIN	

Distância		Direção	Apênd. Prog.	Informação	Dist. Regr.
Total	Parcial				
	0.70			ER 210 <div style="border: 1px solid black; padding: 5px; display: inline-block;"> FIM DE ZONA DE AQUECIMENTO DE PNEUS </div>	
	11				
	0.80			ER 210 <div style="border: 1px solid black; padding: 2px; display: inline-block;"> N 32°46'14.60" W 17°11'20.49" </div> 	
	12			T-1 <div style="border: 1px solid black; padding: 2px; display: inline-block;">9</div> 	

FONTE DO BISPO RAPOSEIRA Segurança na PEC

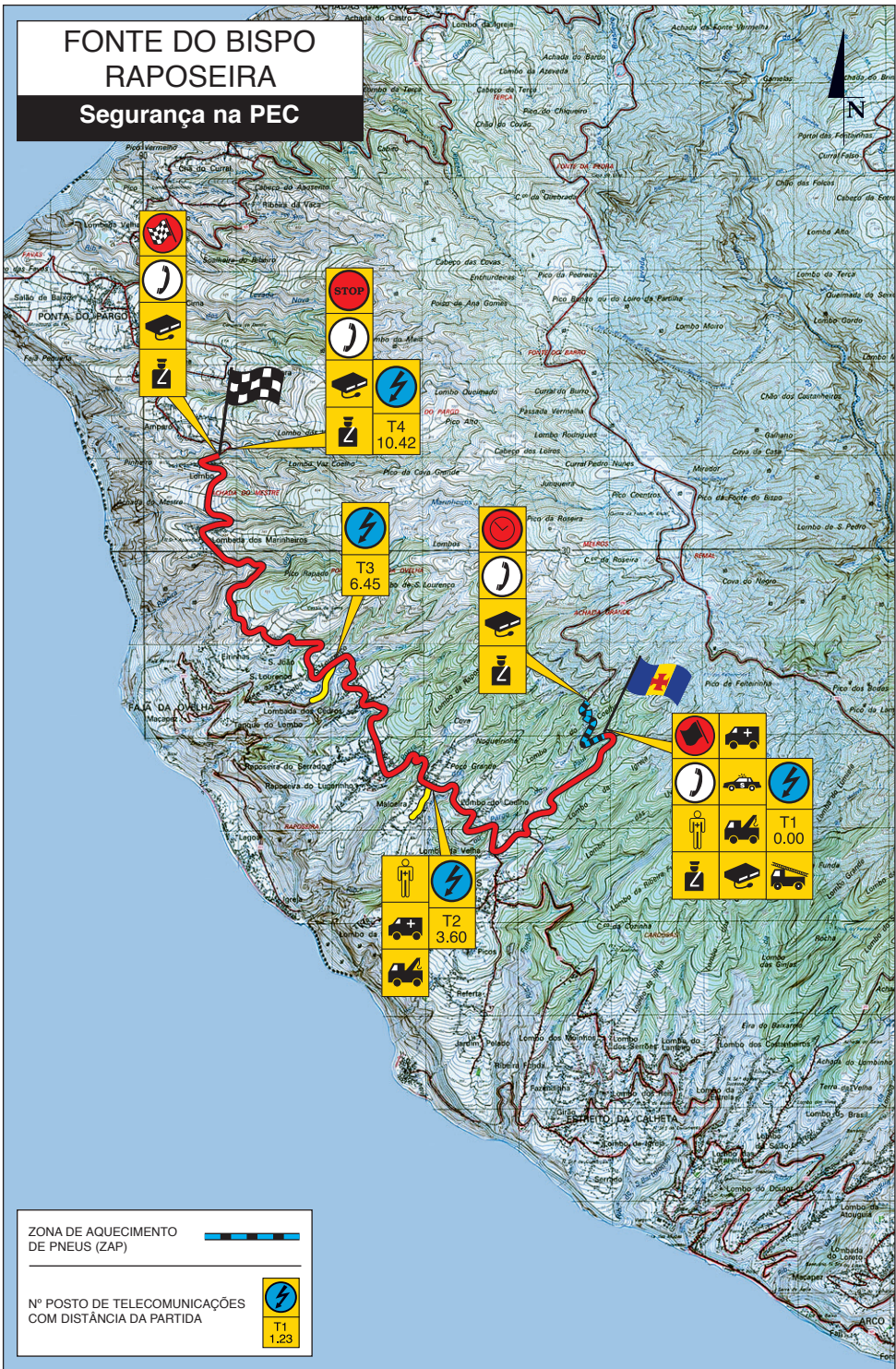

ZONA DE AQUECIMENTO DE PNEUS (ZAP)



Nº POSTO DE TELECOMUNICAÇÕES COM DISTÂNCIA DA PARTIDA



FORTE DO BISPO-RAPOSEIRA • PEC 9 - 17:15h

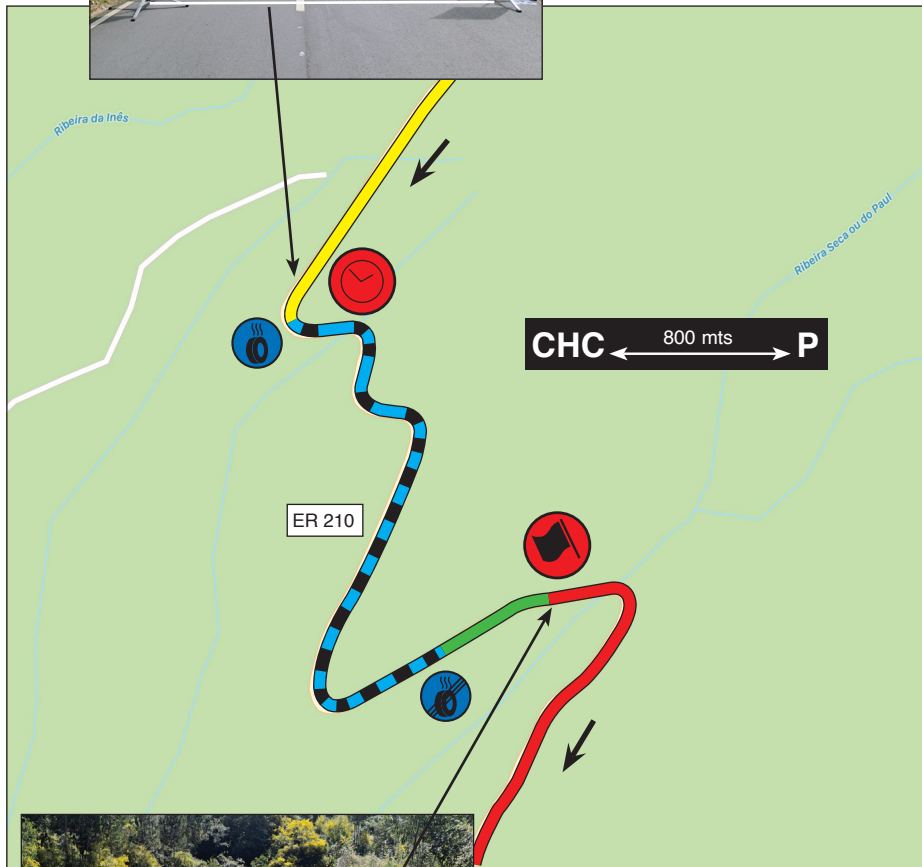

FONTE DO BISPO-RAPOSEIRA • PEC 9 - 17:15h

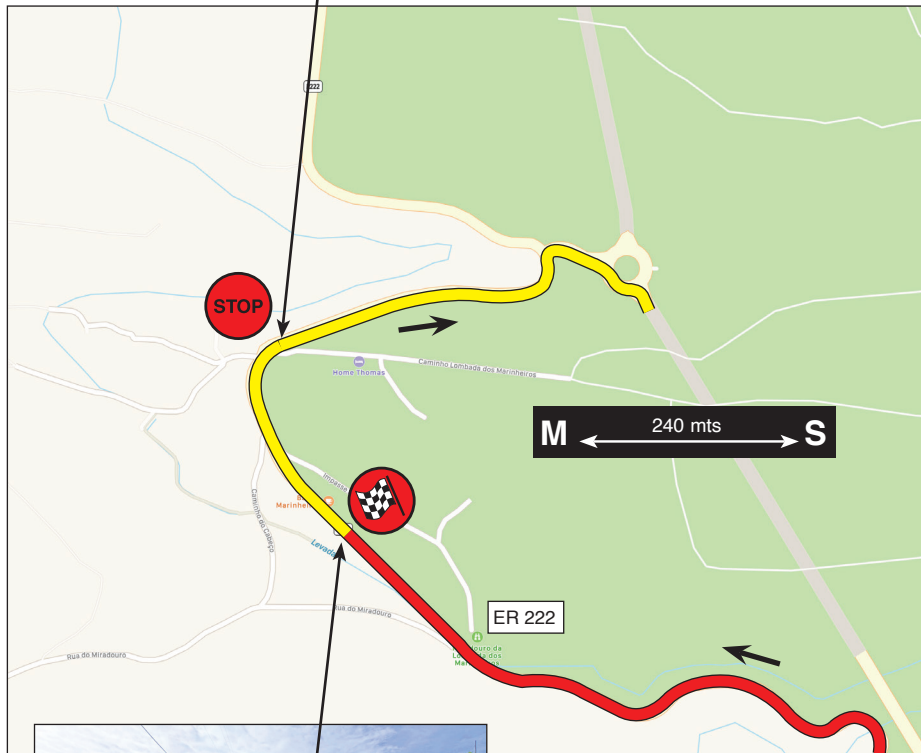



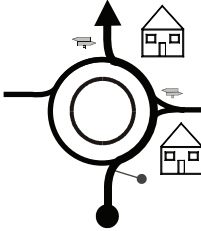
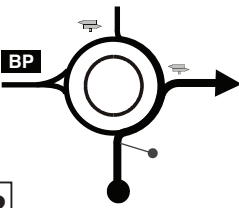
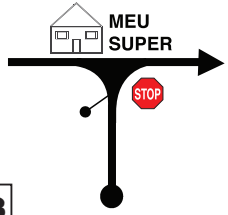
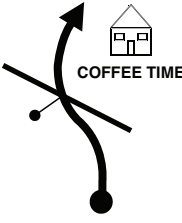
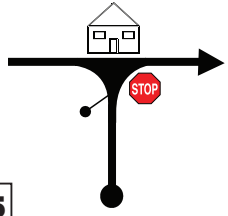

CH 8A - FONTE DO BISPO		DISTÂNCIA		ETAPA		Página	
CH 9A - C. F. PRAZERES/M. ABASTECEDOR - PA (D)		17.34 Km		SECÇÃO		89	
Prova Especial		9		MÉDIA		TEMPO	
Fonte do Bispo-Raposeira 2		10.18 Kms		41.6 Km/h		25 MIN	
Distância		Direção		Informação		Dist. Regr.	
Total	Parcial						
0.00	0.00	<p>1 10.18</p>		<p>ER 210</p> <p>N 32°46'14.60" W 17°11'20.49"</p> <p>T-1</p> <p>9</p>		17.34	
1.58	1.58	<p>2 8.60</p>		<p>ER 210</p> <p>CAMINHO LOMBO DA VELHA</p> <p>CAMINHO LOMBO DA VELHA</p> <p>LEVADA </p> <p>ER 222</p>		15.76	
2.04	0.46	<p>3 8.14</p>		<p>ER 222</p> <p>FUNHAL PORTO MONIZ</p> <p>SAÍDA DE EMERGÊNCIA</p> <p>T-2</p> <p>N 32°45'55.66" W 17°12'30.53"</p>		15.30	
3.60	1.56	<p>4 6.58</p>		<p>ER 222</p> <p>FAJÃ DA OVELHA</p> <p>FUNHAL</p> <p>SAÍDA DE EMERGÊNCIA</p> <p>T-3</p> <p>N 32°46'39.72" W 17°13'7.01"</p>		13.74	
6.45	2.85	<p>5 3.73</p>				10.89	

CH 8A - FONTE DO BISPO		DISTÂNCIA		ETAPA	1	Página
CH 9A - C. F. PRAZERES/M. ABASTECEDOR - PA (D)		17.34 Km		SECÇÃO	5	90
Prova Especial		9		MÉDIA	TEMPO	
Fonte do Bispo-Raposeira 2		10.18 Kms		41.6 Km/h		25 MIN
Distância		Direção	Alpha	Pitag	Informação	Dist. Repr.
Total	Parcial					
10.18	3.73	<div style="border: 1px solid black; padding: 5px;"> <div style="text-align: right; font-weight: bold;">6</div> <div style="text-align: right; font-weight: bold;">0.00</div> </div>			ER 222 <div style="border: 1px solid black; padding: 2px; display: inline-block;"> N 32°47'18.84" W 17°14'5.12" </div> <div style="border: 1px solid black; padding: 2px; display: inline-block; margin-top: 5px;">9</div>	7.16
10.42	0.24	<div style="border: 1px solid black; padding: 5px;"> <div style="text-align: right; font-weight: bold;">7</div> </div>			ER 222 <div style="border: 1px solid black; padding: 2px; display: inline-block;"> N 32°47'25.11" W 17°14'7.80" </div> <div style="border: 1px solid black; padding: 2px; display: inline-block; margin-top: 5px;">9</div> T-2	6.92
10.73	0.31	<div style="border: 1px solid black; padding: 5px;"> <div style="text-align: right; font-weight: bold;">8</div> </div>			ER 222 <div style="border: 1px solid black; padding: 5px; margin: 5px 0;"> FUNCHAL </div> <div style="border: 1px solid black; padding: 5px; margin: 5px 0;"> PONTA DO PARÇO </div> VE 3	6.61
10.80	0.07	<div style="border: 1px solid black; padding: 5px;"> <div style="text-align: right; font-weight: bold;">9</div> </div>			VE 3 <div style="border: 1px solid black; padding: 5px; margin: 5px 0;"> FUNCHAL </div>	6.54
12.72	1.92	<div style="border: 1px solid black; padding: 5px;"> <div style="text-align: right; font-weight: bold;">10</div> </div>			VE 3 <div style="border: 1px solid black; padding: 5px; margin: 5px 0;"> FAJÃ DA OVELHA </div> <div style="border: 1px solid black; padding: 5px; margin: 5px 0;"> FUNCHAL CALHETA </div>	4.62

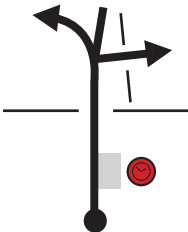
CH 8A - FONTE DO BISPO		DISTÂNCIA		ETAPA		1		Página											
CH 9A - C. F. PRAZERES/M. ABASTECEDOR - PA (D)		17.34 Km		SECÇÃO		5		91											
Prova Especial		9		MÉDIA		TEMPO		25 MIN											
Fonte do Bispo-Raposeira 2		10.18 Kms		41.6 Km/h															
Distância		Direção		Informação		Dist. Regr.													
Total	Parcial																		
13.67	0.95	11		VE 3 TRÂNSITO LOCAL FUNCHAL RIBEIRA BRAVA CALHETA PRAZERES		3.67													
16.43	2.76	12		VE 3 PRAZERES LOMBO DA ROCHA HOTEL CAMINHO LOMBO DA ROCHA		0.91													
16.52	0.09	13		CAMINHO LOMBO DA ROCHA		0.82													
16.94	0.42	14		CAMINHO LOMBO DA ROCHA TRAVESSA DA FIGUEIRA		0.40													
17.08	0.14	15		TRAVESSA DA FIGUEIRA <table border="1"> <tr> <td>ESCOLA →</td> <td>JUNTA FREGUESIA →</td> </tr> <tr> <td>MERCADO ABASTECEDOR →</td> <td>CENTRO DE DIA →</td> </tr> <tr> <td>← IGREJA</td> <td>CENTRO DE SAÚDE →</td> </tr> <tr> <td>← QTA. PEDAGÓGICA</td> <td>SEGURANÇA SOCIAL →</td> </tr> <tr> <td>← CLUBE DESPORTIVO</td> <td>ZONA DESPORTIVA →</td> </tr> </table> CAMINHO DA REFERTA		ESCOLA →	JUNTA FREGUESIA →	MERCADO ABASTECEDOR →	CENTRO DE DIA →	← IGREJA	CENTRO DE SAÚDE →	← QTA. PEDAGÓGICA	SEGURANÇA SOCIAL →	← CLUBE DESPORTIVO	ZONA DESPORTIVA →	0.26			
ESCOLA →	JUNTA FREGUESIA →																		
MERCADO ABASTECEDOR →	CENTRO DE DIA →																		
← IGREJA	CENTRO DE SAÚDE →																		
← QTA. PEDAGÓGICA	SEGURANÇA SOCIAL →																		
← CLUBE DESPORTIVO	ZONA DESPORTIVA →																		

CH 8A - FONTE DO BISPO	DISTÂNCIA	ETAPA	1	Página
CH 9A - C. F. PRAZERES/M. ABASTECEDOR - PA (D)	17.34 Km	SECÇÃO	5	92
Prova Especial	9	MÉDIA	41.6 Km/h	TEMPO
Fonte do Bispo-Raposeira 2	10.18 Kms			25 MIN

Distância		Direção	Informação	Dist. Regr.						
Total	Parcial									
17.17	0.09	 <p>16</p>	<p>CAMINHO DA REFERTA</p> <table border="1"> <tr> <td>MERCADO ABASTECEDOR</td> <td>↑</td> </tr> <tr> <td>←</td> <td>ESCOLA</td> </tr> <tr> <td>←</td> <td>ZONA DESPORTIVA</td> </tr> </table> <p>IMPASSE DO CAMPO</p>	MERCADO ABASTECEDOR	↑	←	ESCOLA	←	ZONA DESPORTIVA	0.17
MERCADO ABASTECEDOR	↑									
←	ESCOLA									
←	ZONA DESPORTIVA									
17.34	0.17	 <p>17</p>	<p>C. F. PRAZERES / M. ABASTECEDOR PARQUE DE ASSISTÊNCIAS ENTRADA</p> <table border="1"> <tr> <td rowspan="2"></td> <td>N 32°45'5.31"</td> </tr> <tr> <td>W 17°12'17.40"</td> </tr> <tr> <td colspan="2">9A</td> </tr> </table>		N 32°45'5.31"	W 17°12'17.40"	9A		0.00	
	N 32°45'5.31"									
	W 17°12'17.40"									
9A										











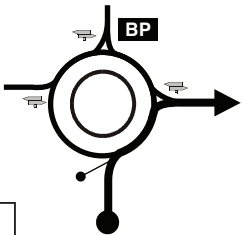

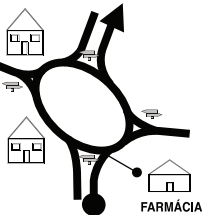



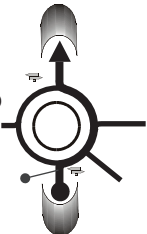

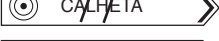

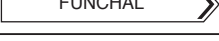
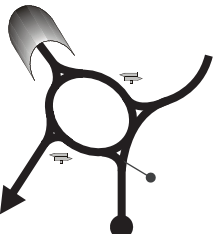

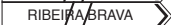



**CAMPO DE FUTEBOL DOS PRAZERES
E MERCADO ABASTECEDOR
PARQUE DE ASSISTÊNCIAS D
(10 MIN)**

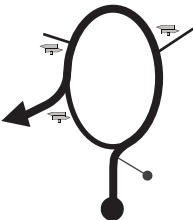

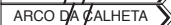
CH 9B - C. F. PRAZERES/M. ABASTECEDOR - PA (D)	DISTÂNCIA	ETAPA	1	Página
CH 9C - PORTO DE RECREIO (REAG.)	12.22 Km	SECÇÃO	5	93
Prova Especial	MÉDIA	TEMPO	20 MIN	
		36.7 Km/h		

Distância		Direção	Informação	Dist. to go Dist. Regr.
Total	Parcial			
0.00	0.00		<p>C. F. PRAZERES / M. ABASTECEDOR PARQUE DE ASSISTÊNCIAS SAÍDA</p> <p>N 32°45'1.00" W 17°12'18.32"</p> <p>9B PA - D</p>	12.22
0.07	0.07		<p>MERCADO ABASTECEDOR SAÍDA</p>	12.15
0.52	0.45		<p>CAMINHO DA REFERTA CAMINHO DA REFERTA</p>	11.70
0.75	0.23		<p>CAMINHO LOMBO DA ROCHA CAMINHO LOMBO DA ROCHA</p>	11.47
1.20	0.45		<p>CAMINHO LOMBO DA ROCHA</p> <p>VE 3</p>	11.02

CH 9B - C. F. PRAZERES/M. ABASTECEDOR - PA (D)	DISTÂNCIA	ETAPA	1	Página
CH 9C - PORTO DE RECREIO (REAG.)		12.22 Km	SECÇÃO	5
Prova Especial	MÉDIA	36.7 Km/h	TEMPO	20 MIN

Distância		Direção	Informação	Dist. Regr.
Total	Parcial			
1.28	0.08	 <p>6</p>	VE 3  	10.94
5.07	3.79	 <p>7</p>	VE 3    	7.15
7.38	2.31	 <p>8</p>	VE 3      	4.84
9.99	2.61	 <p>9</p>	VE 3        	2.23
10.21	0.22	 <p>10</p>	ROTUNDA DO ARCO DA CALHETA       	2.01

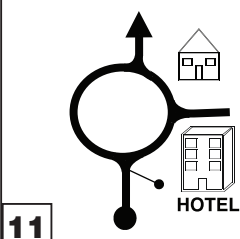
CH 9B - C. F. PRAZERES/M. ABASTECEDOR - PA (D)	DISTÂNCIA	ETAPA	1	Página
CH 9C - PORTO DE RECREIO (REAG.)	12.22 Km	SECÇÃO	5	95
Prova Especial	MÉDIA	TEMPO	20 MIN	
	36.7 Km/h			

Distância		Direção	Informação	Dist. Regr.
Total	Parcial			
12.03	1.82		<p>RUA DA SERRA D'ÁGUA</p> <p>AVENIDA D.MANUEL I</p>	0.19
12.22	0.19	<p>PARQUE ESTACIONAMENTO PORTO DE RECREIO</p> 	<p>AVENIDA D.MANUEL I</p>  <p>N 32°43 '1.78" W 17°10'9.16"</p> <p>9C</p> <p>PISO 0</p>	0.00

PORTO DE RECREIO (SILO) REAGRUPAMENTO (63 MIN. MÁXIMO)

CH 9D - PORTO DE RECREIO - REAG	DISTÂNCIA	ETAPA	1	Página
CH 9E - PORTO DE RECREIO - PF	0.49 Km	SECÇÃO	6	97
Prova Especial	MÉDIA	TEMPO	07 MIN	
	4.2 Km/h			

Distância		Direção	Informação	Dist. to go Dist. Regr.					
Total	Parcial								
0.00	0.00		PORTO DE RECREIO REAGRUPAMENTO <table border="1"> <tr> <td>N</td> <td>32°43 '1.78"</td> </tr> <tr> <td>W</td> <td>17°10'9.16"</td> </tr> </table> <table border="1"> <tr> <td>9D</td> </tr> </table>	N	32°43 '1.78"	W	17°10'9.16"	9D	0.49
N	32°43 '1.78"								
W	17°10'9.16"								
9D									
0.05	0.05			0.44					
0.49	0.44		AVENIDA D. MANUEL I <table border="1"> <tr> <td>N</td> <td>32°43 '1.78"</td> </tr> <tr> <td>W</td> <td>17°10'9.16"</td> </tr> </table> <table border="1"> <tr> <td>PISO 0</td> </tr> </table> MARINA DA CALHETA SILO AUTO	N	32°43 '1.78"	W	17°10'9.16"	PISO 0	0.00
N	32°43 '1.78"								
W	17°10'9.16"								
PISO 0									

**PORTO DE RECREIO (SILO)
PARQUE FECHADO**

**FIM
Rali da Calheta 2026**







Itinerário Alternativo

CH 0A / 1B

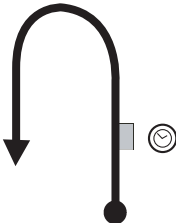

CH 1C

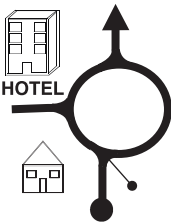
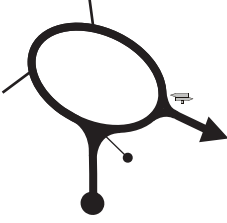
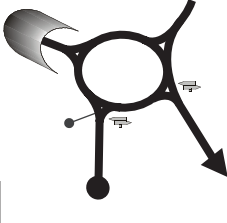
CH 0A/1B - VILA DA CALHETA	DISTÂNCIA	ETAPA	1
CH 1C - C. F. PRAZERES/M. ABASTECEDOR - PA (A)	11.50 Km	SECÇÃO	1
Itinerário Alternativo	MÉDIA	TEMPO	15 MIN
	46.0 Km/h		

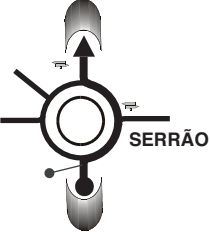
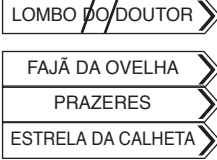
Distância		Direção	Informação	Dist. Regr.
Total	Parcial			
0.00	0.00	 <p>1</p>	AVENIDA D. MANUEL I 	11.50
0.07	0.07	 <p>2</p>	AVENIDA D. MANUEL I RUA SERRA DE ÁGUA	11.43
1.80	1.73	 <p>3</p>	RUA SERRA DE ÁGUA VE 3	9.70
1.95	0.15	 <p>4</p>	VE 3 	9.55
4.52	2.57	 <p>5</p>	VE 3 	6.98

CH 0A/1B - VILA DA CALHETA	DISTÂNCIA	ETAPA	1
CH 1C - C. F. PRAZERES/M. ABASTECEDOR - PA (A)	11.50 Km	SECÇÃO	1
Itinerário Alternativo		MÉDIA	46.0 Km/h
		TEMPO	15 MIN



Distância		Direção	Informação	Dist. Reqr.
Total	Parcial			
6.82	2.30		VE 3 EST. DA CALHETA PORTO MONIZ PTA. DO PARGO PRAZERES	4.68
		CONTINUA CH 0A/1B CH 1C PÁGINA 17 DESENHO 11		

CH 1I / 3C

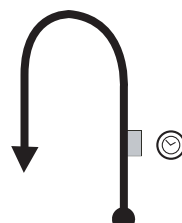

CH 2A / 4A

CH 11/3C - PRAZERES	DISTÂNCIA	ETAPA	1
CH 2A/4A - SANTA	36.74 Km	SECÇÃO	2/3
<i>Itinerário Alternativo</i>		MÉDIA	44.1 Km/h
		TEMPO	50 MIN

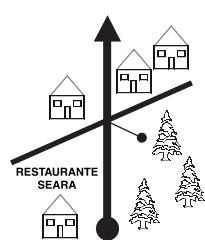
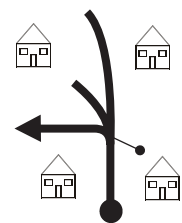
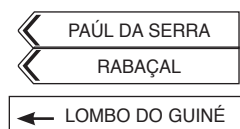
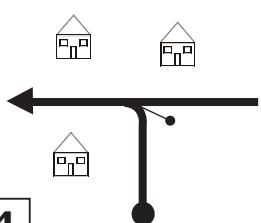
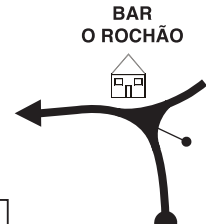
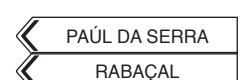
Distância		Direção	Informação	Dist. Regr.
Total	Parcial			
0.00	0.00	 <p>1</p>	ER 222 	36.74
0.92	0.92	 <p>2</p>	ER 222	35.82
12.20	11.28	 <p>3</p>	ER 222 	24.54
12.58	0.38	 <p>4</p>	RUA LOMBO DO GUINÉ RUA LOMBO DO GUINÉ	24.16
14.48	1.90	 <p>5</p>	CAMINHO CALES E CHADA CAMINHO CALES E CHADA 	22.26
			ESTRADA DO ROCHÃO	

Rali da Calheta 2025

CH 11/3C - PRAZERES		DISTÂNCIA	ETAPA	1
CH 2A/4A - SANTA			36.74 Km	SECÇÃO
Itinerário Alternativo		MÉDIA	TEMPO	50 MIN
			44.1 Km/h	

Distância		Direção	Informação	Dist. Regr.
Total	Parcial			
18.46	3.98		ESTRADA DO ROCHÃO 	18.28
		6	ER 105	
27.48	9.02		ER 105	9.26
		7		
36.61	9.13		ER 105 	0.13
		8	E.R. 101	
36.74	0.13		ER 101 <div style="border: 1px solid black; padding: 2px;"> N 32°50'41.19" W 17°11'38.51" </div>	0.00
		9	(0.98)	

CH 2A / 4A



CH 3A / 5A

CH 2A/4A - SANTA	DISTÂNCIA	ETAPA	1
CH 3A/5A - C. F. PRAZERES (REAG.)	39.35 Km	SECÇÃO	2/3
Itinerário Alternativo	MÉDIA	TEMPO	55 MIN
	42.9 Km/h		

Distância		Direção	Informação	Dist. Regr.
Total	Parcial			
0.00	0.00	<p>1</p>	ER 101 	39.35
0.10	0.10	<p>2</p>	ER 101 	39.25
18.24	18.14	<p>3</p>	ER 105 ER 105 	21.11
22.21	3.97	<p>4</p>	ESTRADA DO ROCHÃO ESTRADA DO ROCHÃO 	17.14
24.10	1.89	<p>5</p>	CAMINHO CALES E CHADA CAMINHO CALES E CHADA RUA LOMBO DO GUINÉ	15.25

CH 2A/4A - SANTA	DISTÂNCIA	ETAPA	1
CH 3A/5A - C. F. PRAZERES (REAG.)	39.35 Km	SECÇÃO	2/3
Itinerário Alternativo	MÉDIA	TEMPO	55 MIN
	42.9 Km/h		

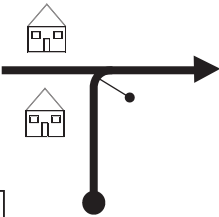
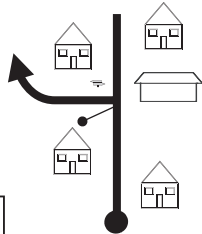
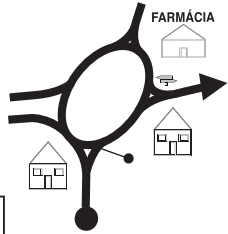
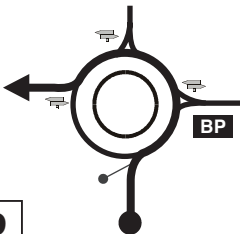









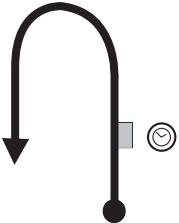

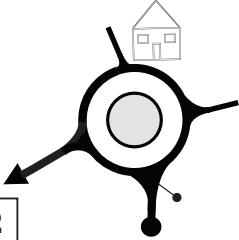

Distância		Direção	Informação	Dist. Regr.
Total	Parcial			
24.48	0.38	 <p>6</p>	<p>RUA LOMBO DO GUINÉ</p> <p>ER 222</p>	14.87
33.31	8.83	 <p>7</p>	<p>ER 222</p> <p>JARDIM DO MAR</p> <p>ESTREITO DA CALHETA</p> <p>ER 223</p>	6.04
34.77	1.46	 <p>8</p>	<p>ER 223</p> <p>PORTO MONIZ</p> <p>PONTA DO PARGO</p> <p>PRAZERES</p> <p>VE 3</p>	4.58
38.55	3.78	 <p>9</p>	<p>VE 3</p> <p>ÁREA DE SERVIÇO</p> <p>PORTO MONIZ</p> <p>PONTA DO PARGO</p> <p>PRAZERES</p> <p>PRAZERES LOMBO DA ROCHA</p> <p>HOTEL</p>	0.80
		<p>CONTINUE/CONTINUA</p> <p>CH 2A/4A</p> <p>CH 3A/5A</p> <p>PAGE/PÁGINA 39/55</p> <p>DRAWING/DESENHO 14</p>		

CH 5D / 7C

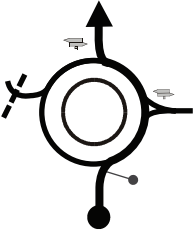

CH 6A / 8A

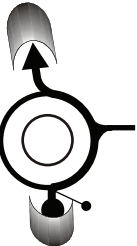

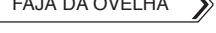



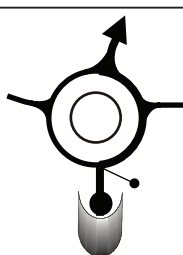
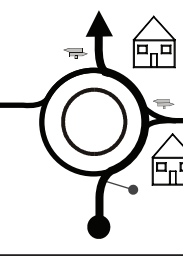
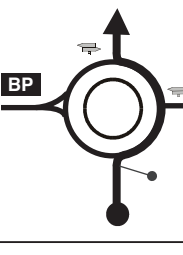
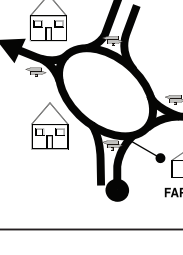
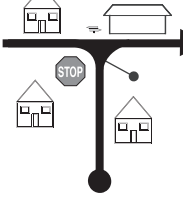



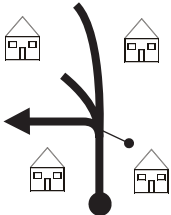

CH 5D/7C - PONTA DO PARÇO	DISTÂNCIA	ETAPA	1
CH 6A/8A - FONTE DO BISPO	40.35 Km	SECÇÃO	4/5
Itinerário Alternativo	MÉDIA	TEMPO	50 MIN
	48.4 Km/h		

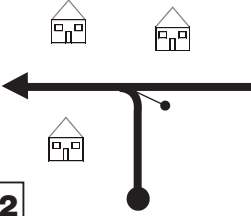
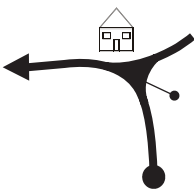
Distância		Direção	Informação	Dist. Regr.
Total	Parcial			
0.00	0.00	 <p>1</p>	ER 101 	40.35
0.11	0.11	 <p>2</p>	ER 101    VE 3	40.24
0.89	0.78	 <p>3</p>	VE 3  	39.46
1.69	0.80	 <p>4</p>	VE 3   	38.66
3.07	1.38	 <p>5</p>	VE 3   	37.38

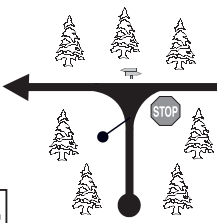
CH 5D/7C - PONTA DO PARGO	DISTÂNCIA	ETAPA	1	
CH 6A/8A - FONTE DO BISPO		40.35 Km	SECÇÃO	4/5
Itinerário Alternativo		MÉDIA	TEMPO	50 MIN
		48.4 Km/h		

Distância		Direção	Informação	Dist. Regr.
Total	Parcial			
5.02	1.95		VE 3 FAJÃ DA OVELHA FUNCHAL CALHETA	35.33
5.97	0.95		VE 3 TRÂNSITO LOCAL FUNCHAL RIBEIRA BRAVA CALHETA PRAZERES	34.38
8.74	2.77		VE 3 PRAZERES LOMBO DA ROCHA HOTEL FUNCHAL RIB. BRAVA CALHETA	31.61
12.55	3.81		VE 3 JARDIM DO MAR PAUL DO MAR FARMÁCIA FUNCHAL RIBEIRA BRAVA CALHETA EST. DA CALHETA	27.80
14.07	1.52		ER 223 PRAZERES PORTO MONIZ CALHETA HOSPITAL DA CALHETA ER 222	26.28

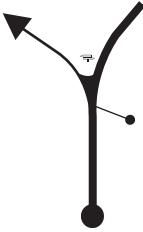
CH 5D/7C - PONTA DO PARÇO	DISTÂNCIA	ETAPA	1
CH 6A/8A - FONTE DO BISPO	40.35 Km	SECÇÃO	4/5
Itinerário Alternativo	MÉDIA	TEMPO	50 MIN
	48.4 Km/h		

Distância		Direção	Informação	Dist. Regr.
Total	Parcial			
22.92	8.85	 <p>11</p>	ER 222    RUA LOMBO DO GUINÉ RUA LOMBO DO GUINÉ	17.43
23.30	0.38	 <p>12</p>	CAMINHO CALES E CHADA CAMINHO CALES E CHADA	17.05
25.20	1.90	<p>BAR O ROCHÃO</p>  <p>13</p>	  ESTRADA DO ROCHÃO ESTRADA DO ROCHÃO	15.15
29.18	3.98	 <p>14</p>	   ER 105 ER 105	11.17
36.70	7.52	 <p>15</p>	 	3.65

CH 5D/7C - PONTA DO PARÇO	DISTÂNCIA	ETAPA	1
CH 6A/8A - FONTE DO BISPO	40.35 Km	SECÇÃO	4/5
Itinerário Alternativo	MÉDIA	TEMPO	50 MIN
	48.4 Km/h		

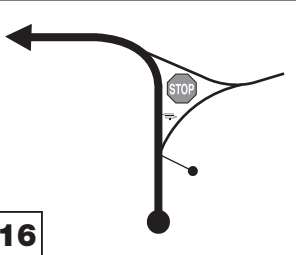
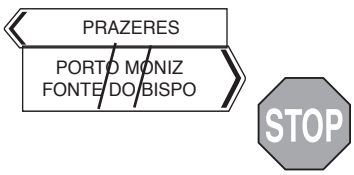
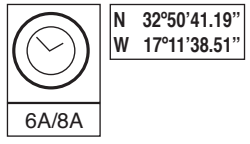
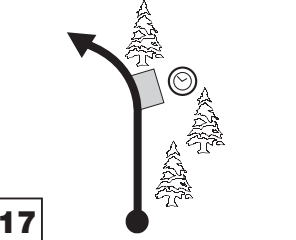
Distância		Direção	Informação	Dist. Regr.
Total	Parcial			
37.09	0.39		<p>ER 105</p> 	3.26
		16	<p>ER 210</p> <p>ER 222</p> 	0.00
40.35	3.26			
		17		

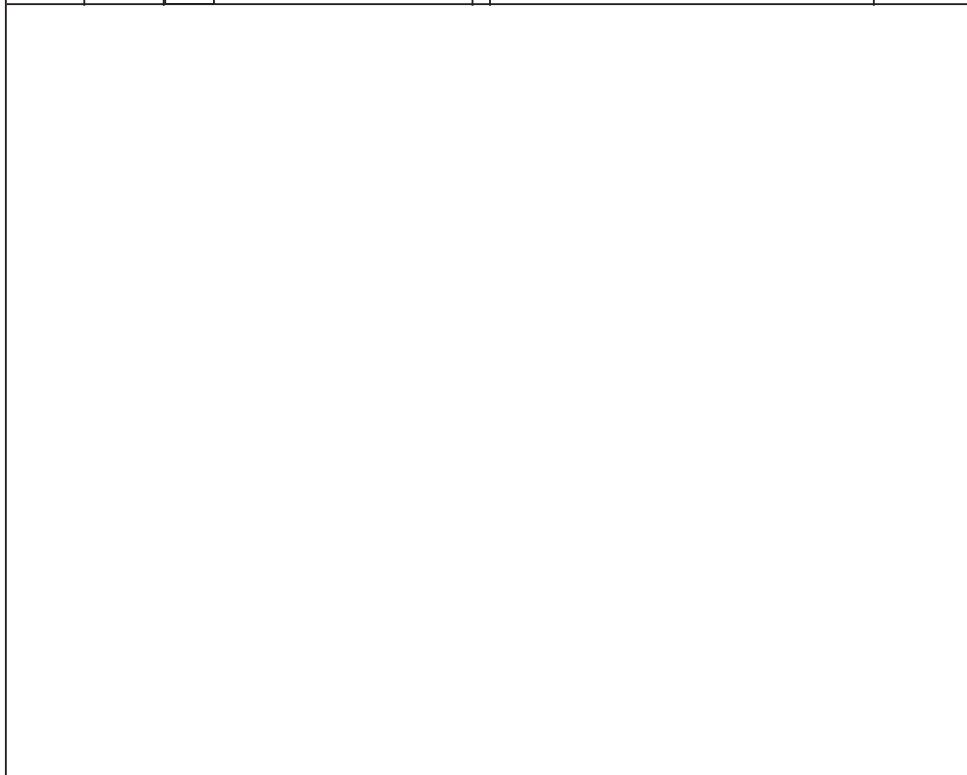







CH 6A / 8A

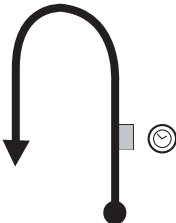

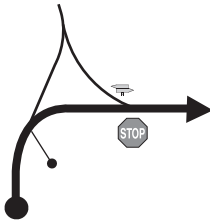
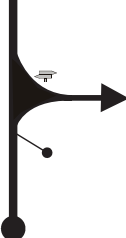
CH 7A / 9A

CH 6A/8A - FONTE DO BISPO	DISTÂNCIA	ETAPA	1
CH 7A/9A - C. F. PRAZERES (REAG. / PA)	32.25 Km	SECÇÃO	4/5
<i>Itinerário Alternativo</i>	MÉDIA	TEMPO	45 MIN
	43.0 Km/h		

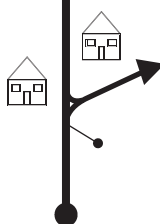
Distância		Direção	Informação	Dist. Regr.
Total	Parcial			
0.00	0.00	 <p>1</p>	ER 222  6A/8A	32.25
3.23	3.23	 <p>2</p>	ER 222	29.02
11.13	7.90	 <p>3</p>	ER 105 ER 105 	21.12
15.10	3.97	 <p>4</p>	ESTRADA DO ROCHÃO ESTRADA DO ROCHÃO  	17.15
16.99	1.89	 <p>5</p>	CAMINHO CALES E CHADA CAMINHO CALES E CHADA RUA LOMBO DO GUINÉ	15.26

CH 6A/8A - FONTE DO BISPO		DISTÂNCIA		ETAPA	
CH 7A/9A - C. F. PRAZERES (REAG. / PA)		32.25 Km		SECÇÃO	
<i>Itinerário Alternativo</i>		MÉDIA		TEMPO	
		43.0 Km/h		45 MIN	
Distância		Direção	Informação	Dist. Regr.	
Total	Parcial				
17.37	0.38	 6	RUA LOMBO DO GUINÉ ER 222	14.88	
26.20	8.83	 7	ER 222 	6.05	
27.66	1.46	 8	ER 223 VE 3	4.59	
31.44	3.78	 9	 VE 3	0.81	
		CONTINUE/CONTINUA CH 6A/8A CH 7A/9A PAGE/PÁGINA 73/91 DRAWING/DESENHO 13			